

Technical data sheet

Beam clamp, multifunctional

Item no. 1485144



The multifunctional beam clamp is suitable for fastening cables, protective pipes and cable sections on steel girders of any size (one clip for every application). Here, the beam clamp is very versatile thanks to various fastening options. Mounting of the beam clamp is quick and efficient, with no need for welding or drilling. It is simply mounted by hammering or pushing into place. The beam clamp can be used in both internal and external areas.



St Steel
ZDM Galvanised, MAGNI 565

Master data

Item no.	1485144
Type	TK MULTI 16
Description 1	Beam clamp
Description 2	multifunctional
Dimension	8-16mm
Material	Steel
Material symbol	St
Surface	Galvanised, MAGNI 565
Surface symbol	ZDM
Smallest sales unit (VG)	100 Piece
Weight	0,12 kg/100 pc.

Technical data

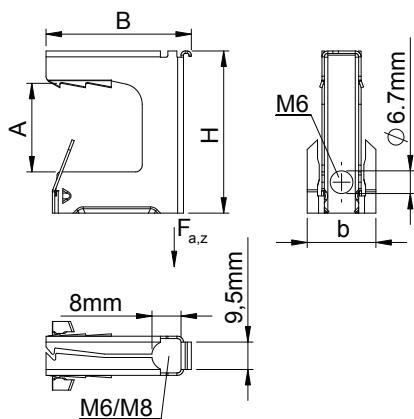

Width	32,00 mm
Height	38,00 mm
Dimension A	16,00 mm
Dimension B	32,00 mm
Dimension D	11,70 mm
Dimension E	29,00 mm
Dimension F	30,00 mm
Dimension G	22
Dimension H	38,00 mm
Connection type/component	Other
Fastening type	Clamp
Breaking load	1,20 kN
Breaking load	1.200,00 N
Flangethickness	8,00 - 16,00 mm
Hinge, adjustable	<input type="checkbox"/>
Hinged	<input type="checkbox"/>