

Technical data sheet

Beam clamp, with cable tie

Item no. 1483645



Support clamp for knocking in with cable tie as individual fastening solution on the support.



St	Steel
ZL	Zinc slat

Master data

Item no.	1483645
Type	BCCT 4-8 L365
Description 1	Beam clamp
Description 2	with wire strip 365mm
Dimension	4-8mm
Material	Steel
Material symbol	St
Surface	Zinc slat
Surface symbol	ZL
Smallest sales unit (VG)	50 Piece
Weight	2,00 kg/100 pc.

Technical data

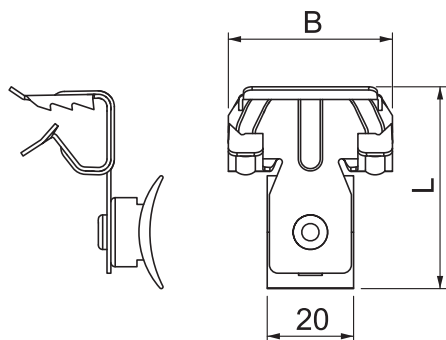

Dimension A	7,50 mm
Connection type/component	Pipe/cable
Max. D	110,00 Ø
Fastening type	Clamp
Breaking load	220,00 N
Flangethickness	4,00 - 8,00 mm
Ribbon cable length	365,00 mm
Hinge, adjustable	<input type="checkbox"/>
Hinged	<input type="checkbox"/>