

# Technical data sheet

## Beam clamp, with cable tie

Item no. 1483643



Support clamp for knocking in with cable tie as individual fastening solution on the support.



St	Steel
ZL	Zinc slat

### Master data

Item no.	1483643
Type	BCCT 4-8 L240
Description 1	Beam clamp
Description 2	with wire strip 240mm
Dimension	4-8mm
Material	Steel
Material symbol	St
Surface	Zinc slat
Surface symbol	ZL
Smallest sales unit (VG)	50 Piece
Weight	1,90 kg/100 pc.

### Technical data

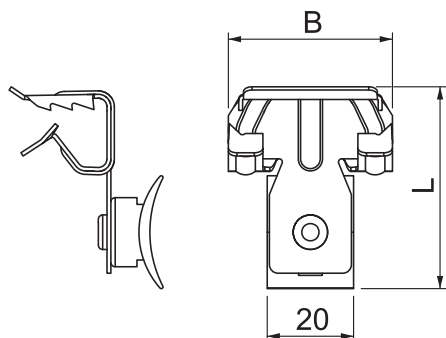

Dimension A	7,50 mm
Connection type/component	Pipe/cable
Max. D	70,00 Ø
Fastening type	Clamp
Breaking load	220,00 N
Flangethickness	4,00 - 8,00 mm
Ribbon cable length	240,00 mm
Hinge, adjustable	<input type="checkbox"/>
Hinged	<input type="checkbox"/>