

Technical data sheet

Beam clamp, with cable tie

Item no. 1483651



Support clamp for knocking in with cable tie as individual fastening solution on the support.



St	Steel
ZL	Zinc slat

Master data

Item no.	1483651
Type	BCCT 14-20 L240
Description 1	Beam clamp
Description 2	with wire strip 240mm
Dimension	14-20mm
Material	Steel
Material symbol	St
Surface	Zinc slat
Surface symbol	ZL
Smallest sales unit (VG)	50 Piece
Weight	2,25 kg/100 pc.

Technical data

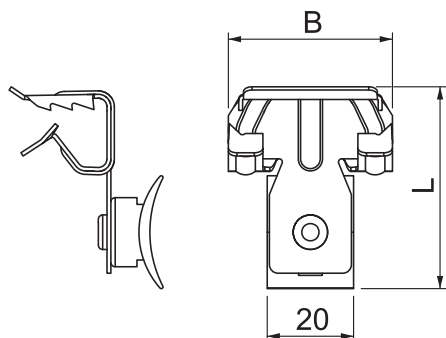

Dimension A	7,50 mm
Connection type/component	Pipe/cable
Max. D	70,00 Ø
Fastening type	Clamp
Breaking load	220,00 N
Flangethickness	14,00 - 20,00 mm
Ribbon cable length	240,00 mm
Hinge, adjustable	<input type="checkbox"/>
Hinged	<input type="checkbox"/>