

Technical data sheet

Clamp clip, single, plastic pressure trough

Item no. 1178563



Suitable for all C profile rails with slot width 18 mm and 22 mm.
Polypropylene pressure sleeve, halogen-free, colour light grey RAL 7035.



VA Stainless steel, rustproof 1.4301

2B Bright, reworked

Master data

Item no.	1178563
Type	2056U 46 A2
Description 1	Clamp clip
Dimension	40-46mm
Material	Stainless steel, material no. 1.4301
Material symbol	A2
Surface	Bright, reworked
Surface symbol	2B
Smallest sales unit (VG)	25 Piece
Weight	9,90 kg/100 pc.

Technical data

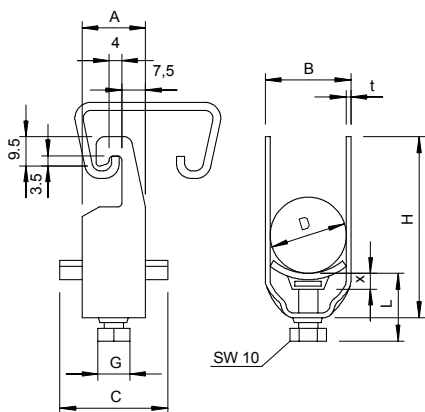

Dimension A	20,00 mm
Dimension B	51,00 mm
Dimension C	40 mm
Dimension G	M8
Dimension H	79,00 mm
Dimension L	37,50 mm
Dimension t	2,00 mm
Dimension x	5,50 mm
Number of cables/pipes	1
Max. tightening torque	5,00 Nm
for 1 cable H	79,00 mm
for 1 cable L	37,50 mm
for pipe diameter	40 mm
for rail with slot width	18,00 - 22,00 mm
Halogen-free	<input checked="" type="checkbox"/>
With plastic trough	<input checked="" type="checkbox"/>
With metal trough	<input type="checkbox"/>
Mounting type	Profile rail
Impact-resistant	<input type="checkbox"/>
Clamping range D	40,00 - 46,00 mm

Technical data sheet

Clamp clip, single, plastic pressure trough

Item no. 1178563



Technical data

Surface addition	Untreated
Material addition	Rustproof steel