

Technical data sheet

Clamp clip, single, plastic pressure trough

Item no. 1178512



Suitable for all C profile rails with slot width 18 mm and 22 mm.
Polypropylene pressure sleeve, halogen-free, colour light grey RAL 7035.



VA Stainless steel, rustproof 1.4301

2B Bright, reworked

Master data

Item no.	1178512
Type	2056U 16 A2
Description 1	Clamp clip
Dimension	12-16mm
Material	Stainless steel, material no. 1.4301
Material symbol	A2
Surface	Bright, reworked
Surface symbol	2B
Smallest sales unit (VG)	50 Piece
Weight	3,20 kg/100 pc.

Technical data

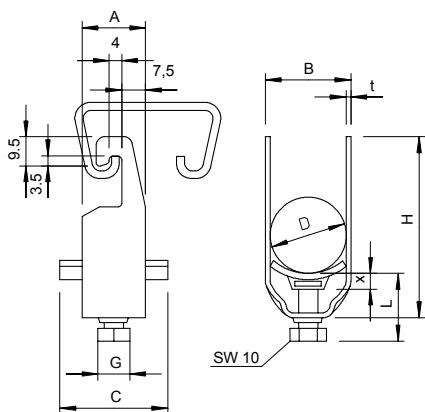

Dimension A	20,00 mm
Dimension B	20,00 mm
Dimension C	34 mm
Dimension G	M6
Dimension H	46,00 mm
Dimension L	34,00 mm
Dimension t	1,50 mm
Dimension x	5,00 mm
Number of cables/pipes	1
Max. tightening torque	3,00 Nm
for 1 cable H	46,00 mm
for 1 cable L	34,00 mm
for pipe diameter	16 mm
for rail with slot width	18,00 - 22,00 mm
Halogen-free	<input checked="" type="checkbox"/>
With plastic trough	<input checked="" type="checkbox"/>
With metal trough	<input type="checkbox"/>
Mounting type	Profile rail
Impact-resistant	<input type="checkbox"/>
Clamping range D	12,00 - 16,00 mm

Technical data sheet

Clamp clip, single, plastic pressure trough

Item no. 1178512



Technical data

Surface addition	Untreated
Material addition	Rustproof steel