

Technical data sheet

Locknut, metric thread

Item no. 2049139



Locknut DIN 46319, with metric thread IEC 423.



PA Polyamide

Master data

Item no.	2049139
Type	116 M63 SW PA
Description 1	Locknut
Dimension	M63
Colour	Black
Material	Polyamide
Material symbol	PA
Smallest sales unit (VG)	25 Piece
Weight	1,26 kg/100 pc.

Technical data

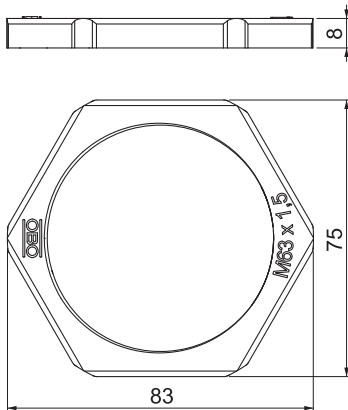

Dimension E	83,00 mm
Dimension L	8,00 mm
WAF	75,00 mm
Thread type	Metric
Thread	M63x1,5
Nominal thread size metric/PG	63
Fibre-glass reinforced	<input type="checkbox"/>
Halogen-free	<input checked="" type="checkbox"/>
Impact-resistant	<input type="checkbox"/>