

Technical data sheet

Height-adjustable cassette for inspection opening,
RKR, brass
Item no. 7409084

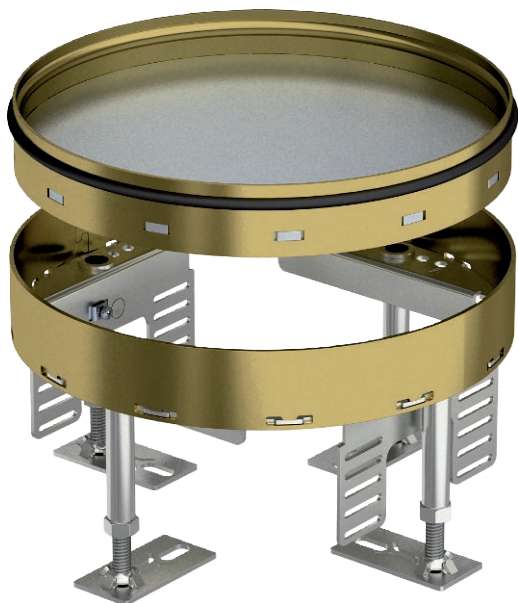

Height-adjustable "blank" cassette for the creation of an inspection opening of nominal size R4 in dry or wet-care floors for indoor use. Only suitable for smooth floor coverings.

Height-adjustable cassette as a blind cassette, two-compartment. 2 APMT2 cover plates can be installed. For the installation of 2 UT3 universal supports for 4 individual installation devices with support ring/support clamp or 6 Modul 45 devices.



CuZn
37 Brass

Master data

Item no.	7409084
Type	RKR2 4M 25
Description 1	Round cassette
Description 2	blank
Dimension	ø 215mm
Material	Brass
Material symbol	CuZn
Smallest sales unit (VG)	1 Piece
Weight	410,00 kg/100 pc.

Technical data

Floor covering thickness	25,00 mm
Floor height	105-155 mm
Number of installable devices	0
Number of mounting boxes	2
Number of cable outlets	0
Version for	Round
Cable outlet version	No cable outlet
Floor care	Wet
Installation depth	105,00 mm
Decouplable	<input type="checkbox"/>
Device support to accept mounting boxes	<input type="checkbox"/>
Nominal size for device installation units	R4
Suitable for raised floor installation	<input checked="" type="checkbox"/>
Suitable for cavity floor installation	<input checked="" type="checkbox"/>
Suitable for underfloor box	250/350
Height-adjustment range	105,00 - 155,00 mm
Opening mechanism	Tool
Approvals	
Schwerlastausführung	<input type="checkbox"/>
Typ des Einbausystems	UT3

Technical data sheet

Height-adjustable cassette for inspection opening,
RKR, brass
Item no. 7409084



Technical data

Dimensions

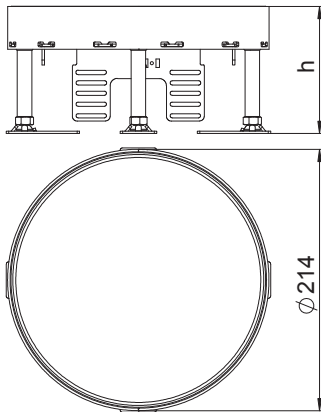

Dimension h	105,00 mm
Installation diameter	215