

Technical data sheet

SurgeController V20, plug-in arrester 335 V



Item no. 5099850



Surge arrester, type 2

- Plug-in arrester, can be separated from base without tools
- Including thermal and dynamic separating device and visual status display
- High current conductivity and long service life



Dimensions

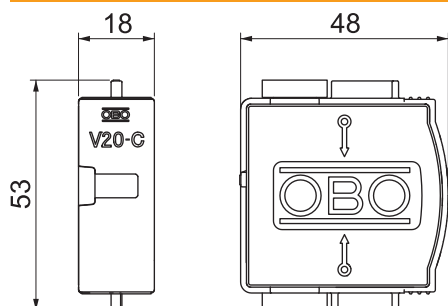

Master data

Item no.	5099850
Type	V20-C 0-335
Description 1	SurgeController V20
Description 2	plug-in arrester
Dimension	335V
Smallest sales unit (VG)	1 Piece
Weight	5,55 kg/100 pc.

Technical data sheet

SurgeController V20, plug-in arrester 335 V

Item no. 5099850



Technical data

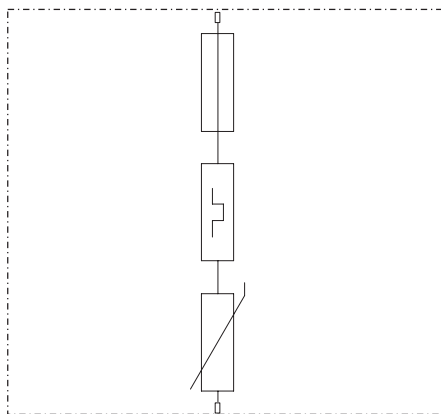

SPD to EN 61643-11	Type 2
SPD to IEC 61643-11	Class II
Test class, type 2	<input checked="" type="checkbox"/>
Nominal voltage	230,00 V
Maximum continuous voltage AC	335,00 V
Max. continuous operating voltage	335,00 V
U max AC	335,00 V
U max DC	420,00 V
Nominal discharge current (8/20)	20 kA
Nominal discharge current (8/20 µs) [L-N]	20,00 kA
Maximum discharge current (8/20 µs)	40,00 kA
Arrester surge current (8/20) [total]	20,00 kA
Protection level	< 1,4 kV
Response time	< 25 ns
Maximum back-up fuse	125,00 A
Temperature range	-40-+80 °C
Pole version	1
Version	1-pin cover; 335 V
Version	1-pole
Mounting type	On basic element
Installation type	On basic element
Protection rating	IP20
Protection rating	IP 20
Blow-out	<input type="checkbox"/>
Division unit TE (17.5 mm)	1
Remote signalling	<input type="checkbox"/>
Telecommunications contact	<input type="checkbox"/>
Integrated back-up fuse	<input type="checkbox"/>
Max. cable cross-section flexible (fine-wire)	25,00 mm ²
Max. cable cross-section rigid (single wire/multi-wire)	35,00 mm ²
Connection cross-section, flexible	2,50 - 25,00 mm ²
Connection cross-section, rigid	2,50 - 35,00 mm ²
Connection cross-section, multi-wire	2,50 - 35,00 mm ²
Signalling on device	Visual