

# Technical data sheet

## SBF 15 tightening strap in fixed lengths

Item no. 6490364

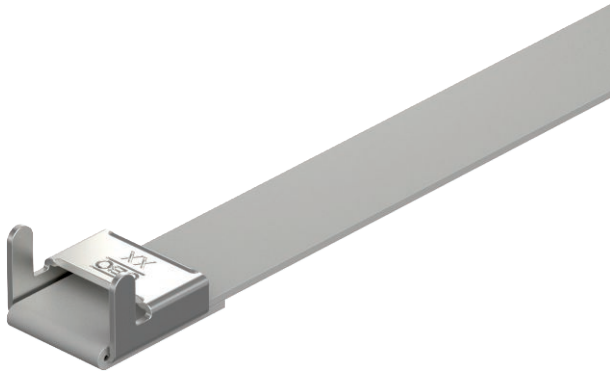

Pre-terminated tightening strap made of rustproof steel with plastic jacketing and tightening strap lock.



**VA** Stainless steel, rustproof 1.4301

Plastic-coated

### Master data

Item no.	6490364
Type	SBF 15-900 A2K
Description 1	Tightening strap with lock
Dimension	15x0,5x900
Colour	Jet black
RAL number	9005
Material	Stainless steel, material no. 1.4301
Material symbol	A2
Quality	1,43
Surface	Plastic-coated
Surface symbol	K
Smallest sales unit (VG)	25 Piece
Weight	6,90 kg/100 pc.

### Technical data

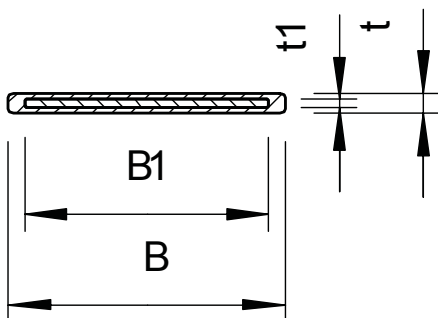

Length	900,00 mm
Dimension B	17,00 mm
Dimension B1	15,00 mm
Dimension t	1,20 mm
Dimension t1	0,50 mm
Dimension	15,0 x 0,5 mm
Version	Smooth
Avg. breaking load	4,19 kN