

Technical data sheet

90° adjustable bend, vertical 60

Item no. 7138172



90° adjustable vertical bend, for all cable tray types with a side height of 60 mm.



A2 Stainless steel, rustproof 1.4301
2B Bright, reworked

Additional product text, instruction | The bend is shipped in an unmounted state. No additional fastening materials are required.

Master data

Item no.	7138172
Type	RGBV 660 A2
Description 1	Adjustable bend
Description 2	vertical
Dimension	60x600
Material	Stainless steel, material no. 1.4301
Material symbol	A2
Surface	Bright, reworked
Surface symbol	2B
Smallest sales unit (VG)	1,00 Piece
Weight	430,00 kg/100 pc.

Technical data sheet

90° adjustable bend, vertical 60

Item no. 7138172



Technical data

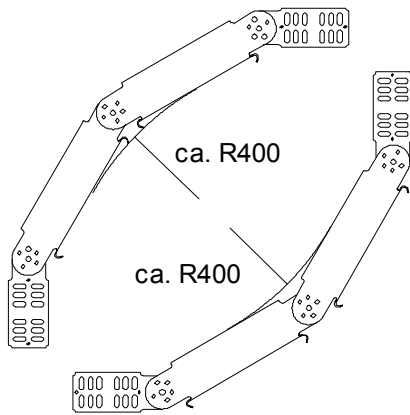

Width	600,00 mm
Side height	60,00 mm
Dimension R	400,00 mm
Connector version	Supplied connectors
Shape	Articulated bend, complete
Plate thickness	1,00 mm
Suitable for maintaining electrical function	<input type="checkbox"/>
Mounting perforation in base	<input type="checkbox"/>
NATO hole pattern	<input type="checkbox"/>
Rustproof steel, pickled	<input type="checkbox"/>
Side perforation	<input type="checkbox"/>
Wide-span version	<input type="checkbox"/>