

Technical data sheet

Adjustable bend element, vertical 60

Item no. 7005342

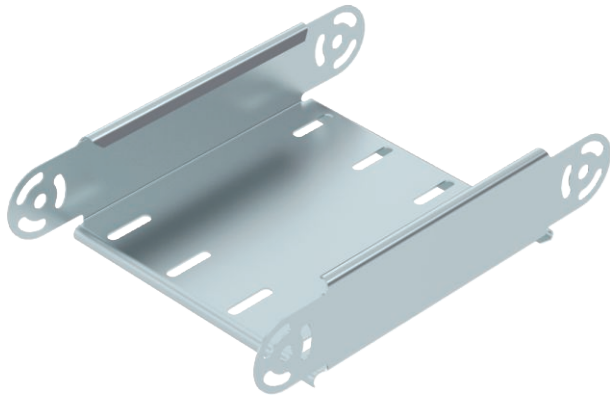

Adjustable vertical bend element, for all cable tray types with a side height of 60 mm.

RGV 60 adjustable connectors should be ordered separately and in the appropriate quantity.



St Steel

FS Strip galvanised

Master data

Item no.	7005342
Type	RGBEV 620 FS
Description 1	Adjustable bend element
Description 2	vertical
Dimension	60x200
Material	Steel
Material symbol	St
Surface	Strip galvanised
Surface to DIN	DIN EN 10346
Surface symbol	FS
Smallest sales unit (VG)	1 Piece
Weight	63,60 kg/100 pc.

Technical data

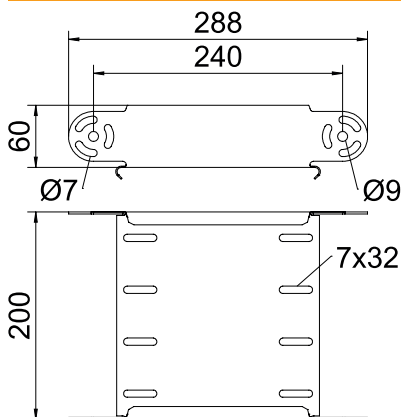

Width	200,00 mm
Side height	60,00 mm
Dimension B	200,00 mm
Connector version	Without connectors
Shape	Articulated bend element
Plate thickness	1,00 mm
Dimension	288 x 200 x 60 mm
Suitable for maintaining electrical function	<input type="checkbox"/>
Mounting perforation in base	<input type="checkbox"/>
NATO hole pattern	<input type="checkbox"/>
Change of direction	Vertical, rising/falling
Rustproof steel, pickled	<input type="checkbox"/>
Side perforation	<input type="checkbox"/>
Wide-span version	<input type="checkbox"/>