

Technical data sheet

45° bend 60

Item no. 6043763

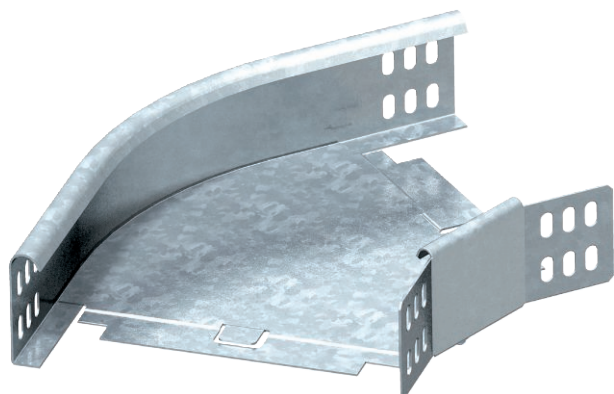

45° bend, horizontal, for all cable tray types of 60 mm side height.

The fitting is shipped in an unmounted state. The WKV 60 angle connector is designed for 90° bends and can be adjusted to 45° on site. Including appropriate fastening material.



St	Steel
FS	Strip galvanised

Master data

Item no.	6043763
Type	RB 45 610 FS
Description 1	45° bend
Description 2	horizontal + angle connector
Dimension	60x100
Material	Steel
Material symbol	St
Surface	Strip galvanised
Surface to DIN	DIN EN 10346
Surface symbol	FS
Smallest sales unit (VG)	1 Piece
Weight	57,60 kg/100 pc.

Technical data

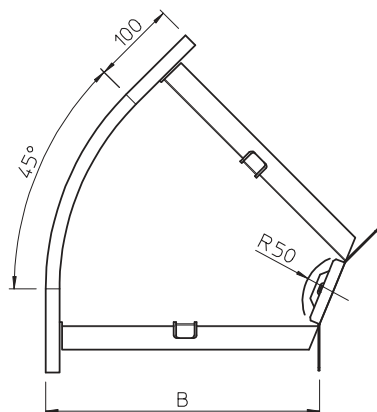

Width	100,00 mm
Side height	60,00 mm
Dimension B	100,00 mm
Dimension R	50,00 mm
Bend (angle)	45°
Connector version	Supplied connectors
Plate thickness	1,25 mm
Suitable for maintaining electrical function	<input type="checkbox"/>
Mounting perforation in base	<input type="checkbox"/>
NATO hole pattern	<input type="checkbox"/>
Change of direction	Horizontal
Rustproof steel, pickled	<input type="checkbox"/>
Side perforation	<input type="checkbox"/>
Wide-span version	<input type="checkbox"/>