

# Technical data sheet

## 90° vertical bend, falling 85

Item no. 7007291

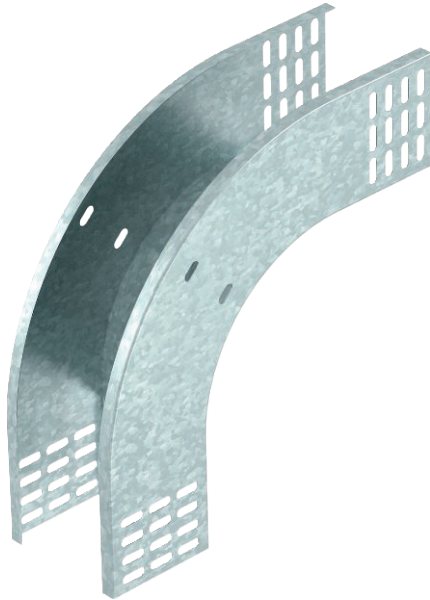

90° vertical bend, falling, for all cable tray types of 85 mm side height.

The vertical bend is pushed over the end of the cable tray and screwed tight. Fastening materials should be ordered separately.



- St** Steel
- FT** Hot-dip galvanised

### Master data

Item no.	7007291
Type	RBV 860 F FT
Description 1	90° vertical bend
Description 2	falling
Dimension	85x600
Material	Steel
Material symbol	St
Surface	Hot-dip galvanised
Surface to DIN	DIN EN ISO 1461
Surface symbol	FT
Smallest sales unit (VG)	1 Piece
Weight	174,70 kg/100 pc.

### Technical data

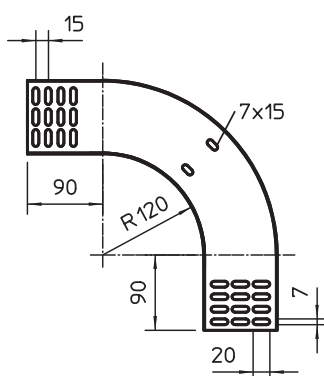

Width	600,00 mm
Side height	85,00 mm
Dimension B	600,00 mm
Bend (angle)	90°
Connector version	Without connectors
Plate thickness	1,00 mm
Suitable for maintaining electrical function	<input type="checkbox"/>
Mounting perforation in base	<input type="checkbox"/>
NATO hole pattern	<input type="checkbox"/>
Change of direction	Vertical, falling
Rustproof steel, pickled	<input type="checkbox"/>
Side perforation	<input type="checkbox"/>
Wide-span version	<input type="checkbox"/>