

# Technical data sheet

## 90° vertical bend, falling 60

Item no. 7006766



90° vertical bend, falling, for all cable tray types of 60 mm side height.

The vertical bend is pushed over the end of the cable tray and screwed tight. Fastening materials should be ordered separately.



**VA** Stainless steel, rustproof 1.4571

**2B** Bright, reworked

### Master data

Item no.	7006766
Type	RBV 650 F A4
Description 1	90° vertical bend
Description 2	falling
Dimension	60x500
Material	Stainless steel, material no. 1.4571
Material symbol	A4
Surface	Bright, reworked
Surface symbol	2B
Smallest sales unit (VG)	1 Piece
Weight	153,00 kg/100 pc.

### Technical data

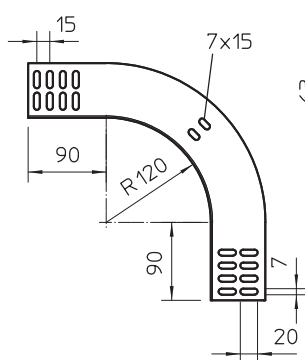

Width	500,00 mm
Side height	60,00 mm
Dimension B	500,00 mm
Bend (angle)	90°
Connector version	Without connectors
Plate thickness	1,00 mm
Suitable for maintaining electrical function	<input type="checkbox"/>
Mounting perforation in base	<input type="checkbox"/>
NATO hole pattern	<input type="checkbox"/>
Change of direction	Vertical, falling
Rustproof steel, pickled	<input type="checkbox"/>
Side perforation	<input type="checkbox"/>
Wide-span version	<input type="checkbox"/>