

Technical data sheet

90° vertical bend, falling 60

Item no. 7006762



90° vertical bend, falling, for all cable tray types of 60 mm side height.

The vertical bend is pushed over the end of the cable tray and screwed tight. Fastening materials should be ordered separately.



VA Stainless steel, rustproof 1.4571

2B Bright, reworked

Master data

Item no.	7006762
Type	RBV 640 F A4
Description 1	90° vertical bend
Description 2	falling
Dimension	60x400
Material	Stainless steel, material no. 1.4571
Material symbol	A4
Surface	Bright, reworked
Surface symbol	2B
Smallest sales unit (VG)	1 Piece
Weight	130,00 kg/100 pc.

Technical data

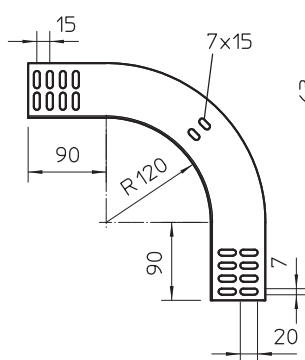

Width	400,00 mm
Side height	60,00 mm
Dimension B	400,00 mm
Bend (angle)	90°
Connector version	Without connectors
Plate thickness	1,00 mm
Suitable for maintaining electrical function	<input type="checkbox"/>
Mounting perforation in base	<input type="checkbox"/>
NATO hole pattern	<input type="checkbox"/>
Change of direction	Vertical, falling
Rustproof steel, pickled	<input type="checkbox"/>
Side perforation	<input type="checkbox"/>
Wide-span version	<input type="checkbox"/>