

Technical data sheet

90° vertical bend, falling 110

Item no. 7007474

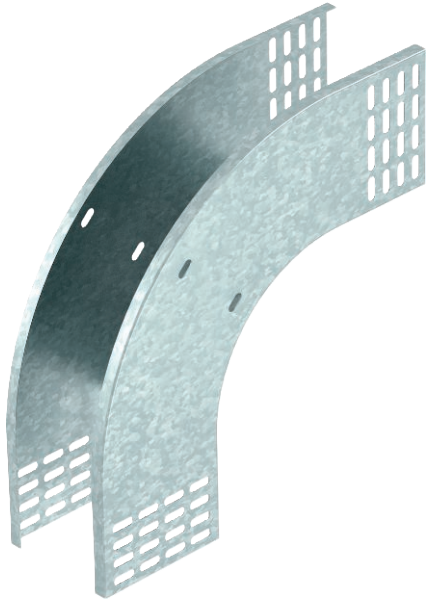

90° vertical bend, falling, for all cable tray types of 110 mm side height.

The vertical bend is pushed over the end of the cable tray and screwed tight. Fastening materials should be ordered separately.



- St** Steel
- FT** Hot-dip galvanised

Master data

Item no.	7007474
Type	RBV 140 F FT
Description 1	90° vertical bend
Description 2	falling
Dimension	110x400
Material	Steel
Material symbol	St
Surface	Hot-dip galvanised
Surface to DIN	DIN EN ISO 1461
Surface symbol	FT
Smallest sales unit (VG)	1 Piece
Weight	172,00 kg/100 pc.

Technical data

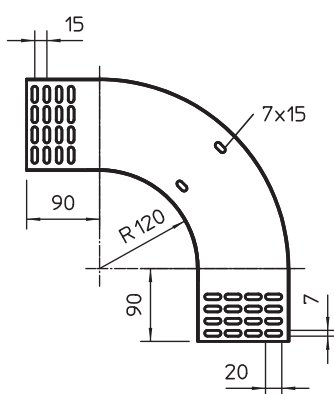

Width	400,00 mm
Side height	110,00 mm
Dimension B	400,00 mm
Bend (angle)	90°
Connector version	Without connectors
Plate thickness	1,00 mm
Suitable for maintaining electrical function	<input type="checkbox"/>
Mounting perforation in base	<input type="checkbox"/>
NATO hole pattern	<input type="checkbox"/>
Change of direction	Vertical, falling
Rustproof steel, pickled	<input type="checkbox"/>
Side perforation	<input type="checkbox"/>
Wide-span version	<input type="checkbox"/>