

# Technical data sheet

## Multifunctional connector 60

Item no. 6225738

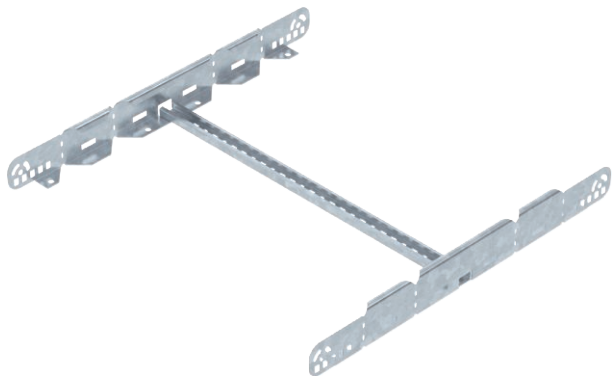

Multifunctional connector for joining cable ladders with a side height of 60 mm. Symmetrical and asymmetrical reductions, infinitely-adjustable bends between 0–60° and add-on tees can be created.



- St** Steel
- FT** Hot-dip galvanised

### Master data

Item no.	6225738
Type	LMFV 660 FT
Description 1	Multifunctional connector
Description 2	for cable ladder
Dimension	60x600
Material	Steel
Material symbol	St
Surface	Hot-dip galvanised
Surface to DIN	DIN EN ISO 1461
Surface symbol	FT
Smallest sales unit (VG)	1 Piece
Weight	158,20 kg/100 pc.

### Technical data

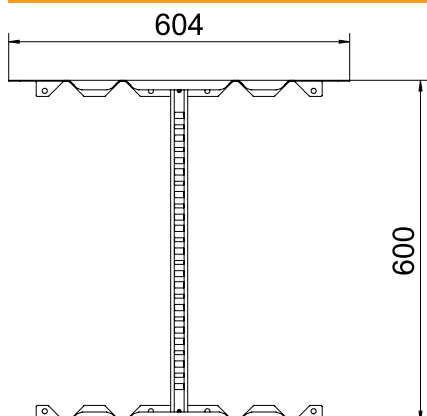

Length	604,00 mm
Width	600,00 mm
Height	60,00 mm
Side height	60,00 mm
Dimension B	600,00 mm
Version	Straight and angle connector
Plate thickness	1,50 mm
Suitable for cable support system width	600,00 - 600,00 mm
Suitable for cable tray system height	60,00 mm
Suitable for cable tray	<input type="checkbox"/>
Suitable for mesh cable tray	<input type="checkbox"/>
Suitable for cable ladder	<input checked="" type="checkbox"/>
Suitable for maintaining electrical function	<input type="checkbox"/>
Adjustable connector, horizontal	<input type="checkbox"/>
Adjustable connector, vertical	<input type="checkbox"/>
Rustproof steel, pickled	<input type="checkbox"/>
Connection type	Screw connector