

Technical data sheet

Cover for 90° bend LBD R3

Item no. 6225996

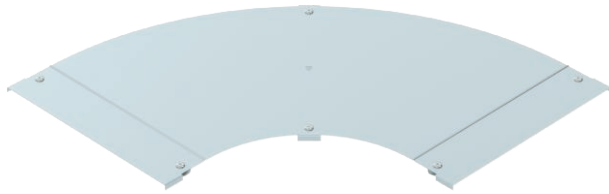

Cover with turn buckles for covering 90° cable ladder bends with welded rungs.



St	Steel
FS	Strip galvanised

Master data

Item no.	6225996
Type	LBD 90 500 R3 FS
Description 1	Cover for 90° bend
Description 2	with turn buckle
Manufacturer	OBO
Dimension	B500
Material	Steel
Material symbol	St
Surface	Strip galvanised
Surface to DIN	DIN EN 10346
Surface symbol	FS
Smallest sales unit (VG)	1 Piece
Weight	550,00 kg/100 pc.

Technical data

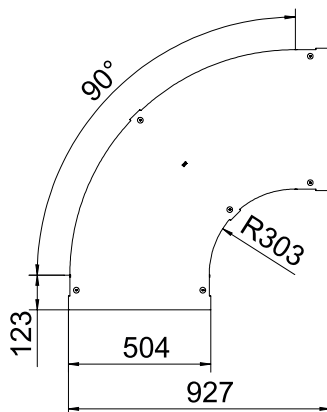

Width	500,00 mm
Dimension B	500,00 mm
Bend (angle)	90°
Fastening type	Turn buckle
Plate thickness	1,25 mm
Suitable for cable tray	<input type="checkbox"/>
Suitable for mesh cable tray	<input type="checkbox"/>
Suitable for cable ladder	<input checked="" type="checkbox"/>
Suitable for maintaining electrical function	<input type="checkbox"/>
Change of direction	Horizontal
Rustproof steel, pickled	<input type="checkbox"/>
Hinged	<input type="checkbox"/>