

Technical data sheet

Cover for 90° bend LBD R3

Item no. 6226072

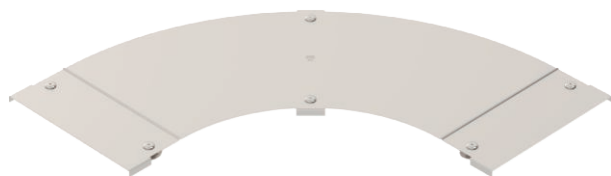

Cover with turn buckles for covering 90° cable ladder bends with welded rungs.



VA	Stainless steel, rustproof 1.4571
2B	Bright, reworked

Master data

Item no.	6226072
Type	LBD 90 300 R3 A4
Description 1	Cover for 90° bend
Description 2	with turn buckle
Manufacturer	OBO
Dimension	B300
Material	Stainless steel, material no. 1.4571
Material symbol	A4
Surface	Bright, reworked
Surface symbol	2B
Smallest sales unit (VG)	1 Piece
Weight	248,00 kg/100 pc.

Technical data

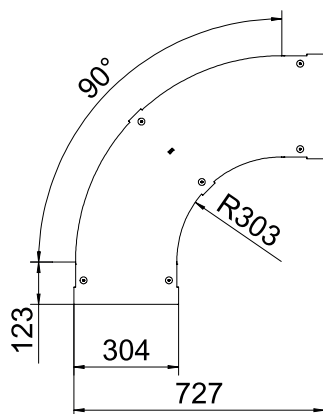

Width	300,00 mm
Dimension B	300,00 mm
Bend (angle)	90°
Fastening type	Turn buckle
Plate thickness	1,00 mm
Suitable for cable tray	<input type="checkbox"/>
Suitable for mesh cable tray	<input type="checkbox"/>
Suitable for cable ladder	<input checked="" type="checkbox"/>
Suitable for maintaining electrical function	<input type="checkbox"/>
Change of direction	Horizontal
Rustproof steel, pickled	<input type="checkbox"/>
Hinged	<input type="checkbox"/>