

Technical data sheet

Add-on tee

Item no. 6225816

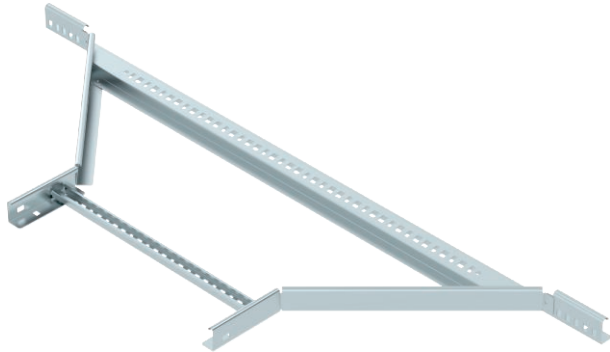

Add-on tee with welded rung for use in the cable ladder types with a side height of 45 mm.



St	Steel
FS	Strip galvanised

Additional product text, instruction
Connectors should be ordered separately and in the appropriate quantity.

Master data

Item no.	6225816
Type	LAA 450 R3 FS
Description 1	Add-on tee
Description 2	for cable ladder
Dimension	45x500
Material	Steel
Material symbol	St
Surface	Strip galvanised
Surface to DIN	DIN EN 10346
Surface symbol	FS
Smallest sales unit (VG)	1,00 Piece
Weight	321,00 kg/100 pc.

Technical data

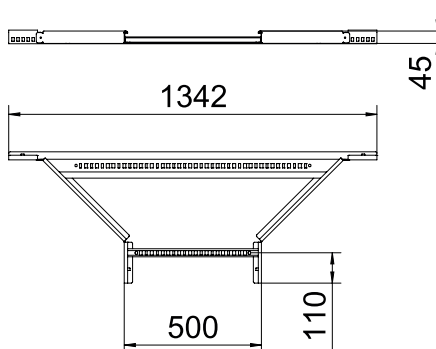

Width	500,00 mm
Side height	45,00 mm
Dimension B	500,00 mm
Dimension R	300,00 mm
Connector version	Without connectors
Rung version	Profile perforated
Side rail version	Flat profile
Suitable for maintaining electrical function	<input type="checkbox"/>
Rail thickness	1,25 mm
Rustproof steel, pickled	<input type="checkbox"/>
Wide-span version	<input type="checkbox"/>