

# Technical data sheet

## Cover for 45° bend

Item no. 7128835

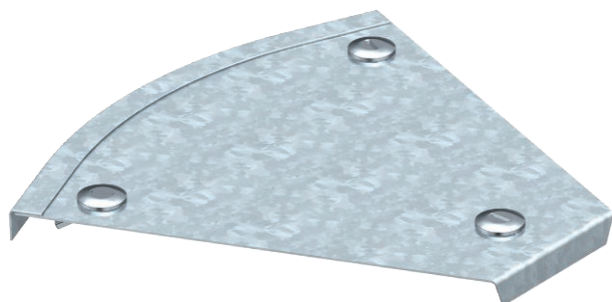

Cover for 45° bend with pre-mounted turn buckle.

The cover can be used with fittings of all side heights.



**St** Steel

**FS** Strip galvanised

### Master data

Item no.	7128835
Type	DFB 45 200 FS
Description 1	45° bend cover
Description 2	with sash locks, RB 45 200
Manufacturer	OBO
Dimension	B200mm
Material	Steel
Material symbol	St
Surface	Strip galvanised
Surface to DIN	DIN EN 10346
Surface symbol	FS
Smallest sales unit (VG)	1 Piece
Weight	36,90 kg/100 pc.

### Technical data

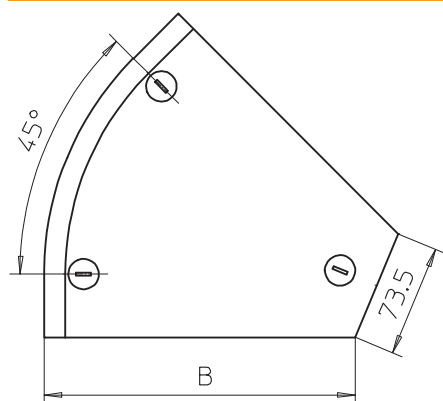

Width	200,00 mm
Side height	35,00 mm
Dimension B	200,00 mm
Dimension H	15,00 mm
Bend (angle)	45°
Number of turn buckles	3,00 pc.
Fastening type	Turn buckle
Plate thickness	1,00 mm
Suitable for cable tray	<input checked="" type="checkbox"/>
Suitable for mesh cable tray	<input type="checkbox"/>
Suitable for cable ladder	<input type="checkbox"/>
Suitable for maintaining electrical function	<input type="checkbox"/>
Change of direction	Horizontal
Rustproof steel, pickled	<input type="checkbox"/>
Hinged	<input type="checkbox"/>