

Technical data sheet

Cover for 45° bend

Item no. 7133986



Cover for 45° bend with pre-mounted turn buckles.
The cover can be used with fittings of all side heights.



VA	Stainless steel, rustproof 1.4571
2B	Bright, reworked

Master data

Item no.	7133986
Type	DFB 45 200 A4
Description 1	45° bend cover
Description 2	with sash locks, for RB 45 200
Manufacturer	OBO
Dimension	B200mm
Material	Stainless steel, material no. 1.4571
Material symbol	A4
Surface	Bright, reworked
Surface symbol	2B
Smallest sales unit (VG)	1 Piece
Weight	35,00 kg/100 pc.

Technical data

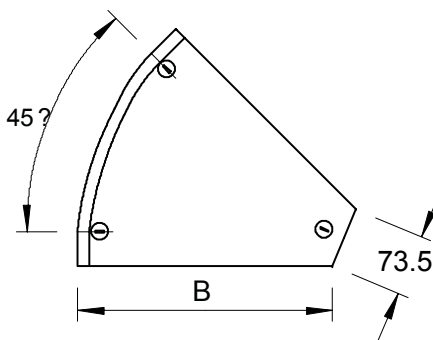

Width	200,00 mm
Side height	35,00 mm
Dimension B	200,00 mm
Bend (angle)	45°
Fastening type	Turn buckle
Plate thickness	1,00 mm
Suitable for cable tray	<input checked="" type="checkbox"/>
Suitable for mesh cable tray	<input type="checkbox"/>
Suitable for cable ladder	<input checked="" type="checkbox"/>
Suitable for maintaining electrical function	<input type="checkbox"/>
Change of direction	Horizontal
Rustproof steel, pickled	<input type="checkbox"/>
Hinged	<input type="checkbox"/>