

Technical data sheet

Wall and support bracket AW 30 F

Item no. 6417043

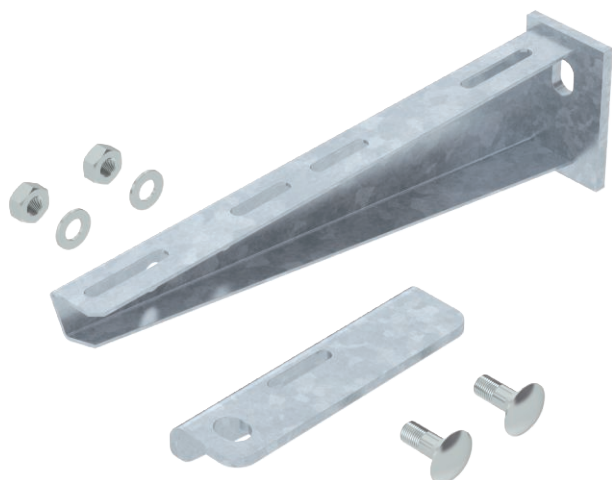

Bracket for mounting on suspended supports or as wall bracket for cable tray routing type above fire protection ceilings and for routing types with cable ladders and cable trays for the maintenance of electrical function according to DIN 4102 Part 12. The brackets are supplied ready-mounted.

The brackets, type AW30F..., are supplied ready-mounted.



St	Steel
FT	Hot-dip galvanised

Product text, scope of delivery | Including one connecting bracket and two truss-head bolts M10 x 25 with nut and washer.

Master data

Item no.	6417043
Type	AW30F31 FT
Description 1	Bracket
Description 2	with connection profile
Dimension	B310mm
Material	Steel
Material symbol	St
Surface	Hot-dip galvanised
Surface to DIN	DIN EN ISO 1461
Surface symbol	FT
Smallest sales unit (VG)	1 Piece
Weight	100,00 kg/100 pc.

Technical data

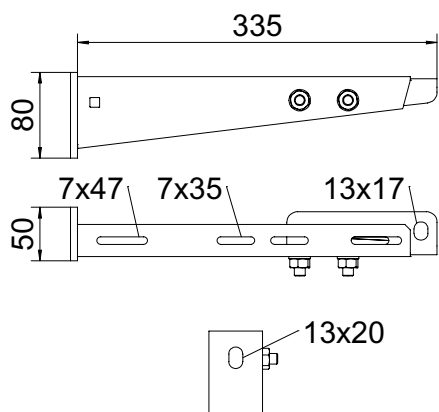

Length	310,00 mm
Width	310,00 mm
Dimension A	50,00 mm
Dimension B	335,00 mm
Dimension b	310,00 mm
Dimension C	320,00 mm
Dimension H	80,00 mm
Version	Wall and support brackets
Version	Wall and support bracket
for width	300,00 mm
Suitable for maintaining electrical function	<input checked="" type="checkbox"/>
Rustproof steel, pickled	<input type="checkbox"/>
Angle range	90,00 - 90,00 °