



Solutions for Photovoltaic Systems

Protection and cable routing for sloping,
flat roof and free-standing systems





Building Connections

OBO BETTERMANN has been producing innovative products and matching solutions for electrical installation for over 100 years. Our focus has always been on protective installations for reliable protection of buildings, people and property. With our many years of experience and comprehensive product range, we are one of the leading manufacturers in this area.

OBO's special spirit of innovation, now and in future, is visible in each of our currently more than 30,000 products. Partnership with the customer is of central importance to us. OBO staff are available to provide highly competent support to customers in all aspects of their projects, including products, installation and planning. This means that you are always on the safe side.



OBO Academy: From the basics to concrete applications

For many years, the OBO Academy has offered a comprehensive portfolio of seminars. At OBO "Advantage through knowledge" is not just a slogan, but a promise: With first-hand information, a link to practical situations and expert knowledge, we offer participants a decisive knowledge advantage. In our seminars, planner days and online seminars, we inform you about current developments, trends, standards and regulations.

The OBO Academy also offers a special training course on the protection of photovoltaic systems (PV systems). Here, you can find out how to best protect your PV system against surge voltages, have the opportunity to ask any questions you have on the subject and you will also receive additional information material for reference.



OBO Support: Benefits for you

Every OBO product comes with various support options. It is developed, manufactured and tested with a high level of competence, from the idea through to the final check. From flawless logistics through to practical information – we provide support at every level. We also offer additional safety by providing conformity certificates for most relevant standards and directives.



Comprehensive protection for photovoltaic systems

The procurement of a PV system is always connected with high levels of investment, which should pay off as quickly as possible. This makes their continuous availability that much more important. As PV systems are installed on a roof or in an open location, integrated within a facade, as a cover on a conservatory with transparent modules or as balcony power stations, they are particularly susceptible to lightning strikes and surge voltages. If a system fails due to surge damage, then earnings will be lost for the period of repair. Additional costs can also incur, for example when replacing of the inverter or of a defective panel.

With OBO, you are on the safe side. This is because we offer a complete system to protect photovoltaic systems. This covers almost all the electrical requirements: from surge voltage protection and earthing systems through to cable support and cable routing systems.

Solutions with a system

This brochure presents our solutions for a permanently safe and quick installation. You can also find answers to a wide range of questions concerning the protection of PV systems:

- How do I install external lightning protection in combination with a PV system?
- How can I maintain the required separation distances to the lightning protection system?
- How do I best protect the inverter?
- What options do I have for the strain relief of vertical cable routing?
- How do I route cables in the area of emergency and escape routes?

The section 'Basic Principles' offers practical information on sloping and flat roofs as well as free-standing systems and solar parks.





External lightning protection
Page 08

Surge protection
Page 18

Earthing systems
Page 20

Equipotential bonding
Page 22

Cable routing Page 26

Structural fire protection
Page 30



Please note: This icon indicates pages with more detailed information when planning and installing PV systems.

Responsible system protection

The installation of a lightning protection system often requires major intervention in the electrical infrastructure of a building. This is reflected in the wide range of standards and regulations to be complied with in this area. The person installing the system is liable for correct fulfillment for 30 years, and the requirements of the insurance company come on top of that.

The specialist company installing an electrical system is required by law to hand it over in perfect condition. According to the low-voltage connection ordinance (NAV), the electrician listed in the energy supplier's installer list may only connect tested and correct systems to the public power grid.

Responsibility of the operator

By feeding in the generated energy, almost every PV system is subject to the requirements of commercial use. According to the accident prevention regulation BGV A3, the system operator is obliged to have the system serviced, checked and repaired professionally. These regular recurring checks of the electrical system components must be carried out by an electrical technician.

The overall responsibility for electrical safety is in the hands of the commissioner.

Photovoltaics Association

People, livestock and property must be protected against damage caused by over-voltages, that are the result of atmospheric influences or switching overvoltages.

VDE 0100-100 (IEC 60364-1)

”

Relevant standards

Low-voltage electrical installations

- DIN VDE 0100-100 (IEC 60364-1)
- DIN VDE 0100-534 (IEC 60364-5-53)
- DIN VDE 0100-410 (IEC 60364-4-41)
- DIN VDE 0100-443 (IEC 60364-4-44)
- DIN EN 60664-1 (IEC 60664-1)

Tests (commissioning test) and documentation

- VDE 0100-600 (IEC 60364-6)
- VDE 0105-100 (EN 50110-1)

Requirements for PV power supply systems

- DIN VDE 0100-712 (IEC 60364-7-712)
- DIN EN 62446 (IEC 62446)
- DIN CLC/TS 61643-12 (IEC 61643-12)
- DIN CLC/TS 50539-12 (CLC/TS 51643-32, IEC 61643-32)
- VDE 0185-305-3 Supplement 5

Lightning protection systems and earthing systems

- DIN EN 62305-1 to -4 (IEC 62305-1 to -4)
- Local additional requirements (e.g. state building regulations in Germany)
- DIN 18014
- DIN VDE 0100-540 (IEC 60364-5-54)

Fire protection in the PV area

- VDE-AR-E 2100-712

Construction regulations

- EN 13501-1/-2, DIN 4102-1/-2 Fire classification of construction products and building elements
- The national and regional construction regulations must be observed with regard to the use of construction products. These include, for example, the state construction regulations in Germany, VKF regulations in Switzerland and OIB directives in Austria.

This list does not claim to be complete.

Please note the respective legal and local requirements.



External lightning protection for roof systems

Adding a PV system into the existing lightning protection concept of a building is often neglected during refitting work. This significantly increases the risk of considerable damage through a direct lightning strike.

The LBO (state construction regulations) requires, for example, a lightning protection system for fire- and personal protection of public buildings



Complete product range, decades of experience

Our comprehensive product range, tested in the OBO BET Test Centre, and our experience prove that we can offer the right solutions for almost any type of system. Lightning strikes are intercepted safely and run to the earth in a controlled manner with the following OBO systems:

- Air-termination rods
- Rod holders
- Ridge conductor holders
- Roof conductor holder for ridge tiles
- Roof conductor holders for various roofing types
- Conventional insulated lightning protection
- Insulated isCon® lightning protection system
- Cable brackets
- Round and flat conductors
- Connection clamps and connection terminals

Our products are available in four different materials:

- Steel (hot-dip galvanised)
- Copper
- Aluminium
- Stainless steel



Four steps to comprehensive protection of PV systems

Step 1

Check the separation distance

If the required separation distance cannot be complied with, then the metallic parts must be interconnected to be able to carry lightning current.

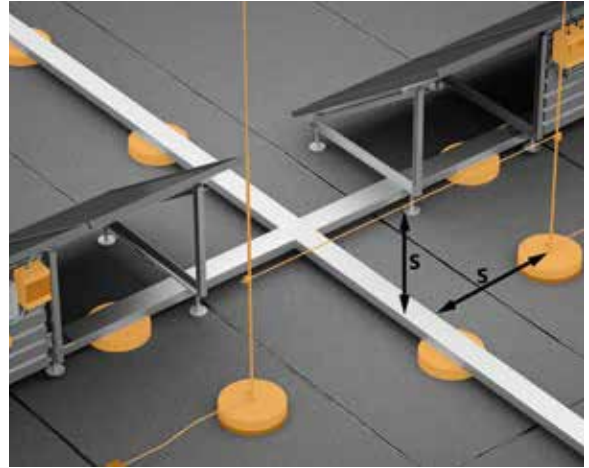

Step 2

Check the safety precautions

Precautions for lightning protection equipotential bonding are used on the DC and the AC side, e.g. lightning current arrester (Type 1).



Step 3:

Considering data cables

Data cables must be included in the protection concept.











Step 4:

Implement equipotential bonding

Local equipotential bonding must be provided on the inverter.





| Overview of protection measures | | | | | |
|---|---|--|-------------------------|---|---|
| Initial situation | Measure | Separation distance according to DIN EN 62305 maintained | Equipotential bonding | Surge protection | Sample product image |
| External lightning protection system (according to DIN EN 62305)  | Adapt the lightning protection system according to DIN EN 62305 | Yes | min. 6 mm ² | DC: Type 2 V20-C 3PH-1000 5094608 |  |
| | | | | AC: Type 1+2 V50 3+NPE 5093526 |  |
| | | No | min. 16 mm ² | DC: Type 1+2 V-PV-T1+2-1000 5094230 |  |
| | | | | AC: Type 1+2 V50 3+NPE 5093526 |  |
| No external lightning protection system, earthing cable connection  | Requirements testing: LBO, VdS 2010, risk analysis, etc | - | | DC: Type 2 V20-C 3PH-1000 5094608 |  |
| | | | | AC: Type 2 V20 3+NPE 5095253 |  |



Protective angle method

Using the protective angle method is only advisable in simple or small buildings and for individual building sections. It should therefore only be used when the building is already protected with air-termination rods whose positions were determined using the rolling sphere or grid method. The protective angle method is well suited for positioning air-termination rods providing merely additional protection for a small number of protruding building parts or structures.

All roof structures must be protected with air-termination rods. It is therefore necessary to observe the relevant separation distance (s) between earthed roof structures and metal systems. If the roof structure has a conductive continuation into the building (e.g. with a stainless steel pipe with a connection to the ventilation or air-conditioning system), then the air-termination rod must be erected at the separation distance (s) from the object to be protected. This distance safely prevents arcing of the lightning current and dangerous spark creation.

α Protective angle

S Separation distance

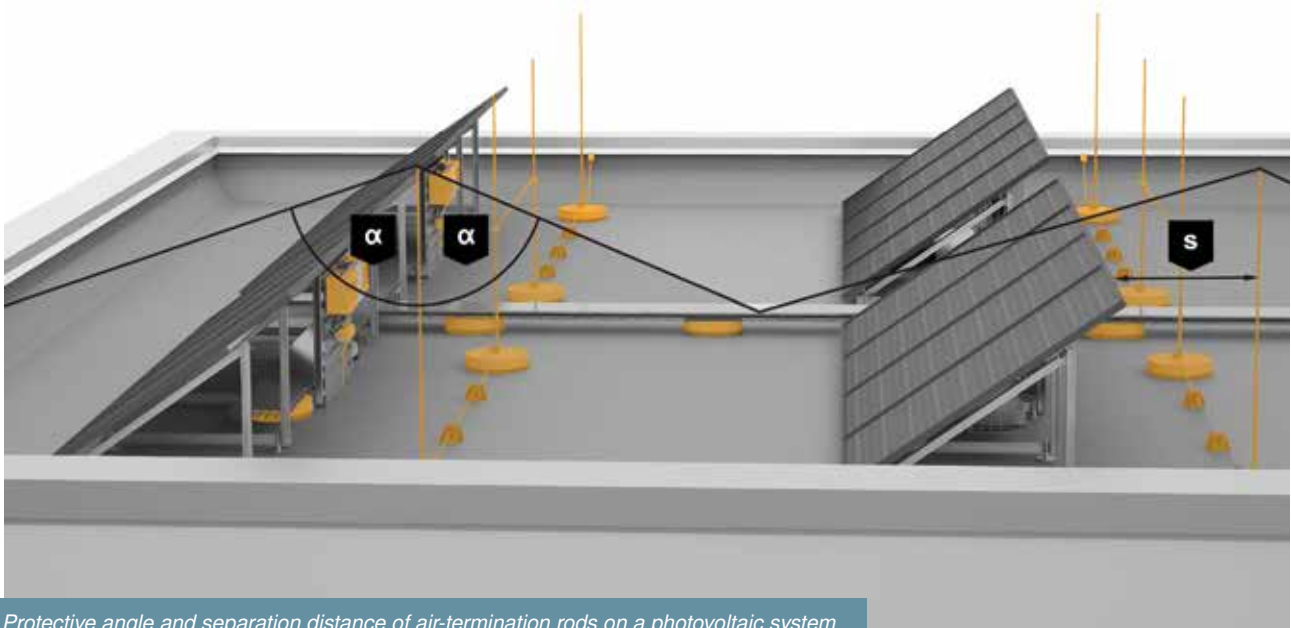

Protective angle and separation distance of air-termination rods on a photovoltaic system

The protective angle (α) for air-termination rods varies according to lightning protection class. You can find the protective angle (α) in the table below for the most common air-termination rods of up to 2 m in length.

The structure to be protected (e.g. building part or device) must be fitted with one or more air-termination rods so that the structure fits fully underneath a cone sheath formed by the tips of the air-termination rods and whose top angle is taken from the table. The areas bordered by the horizontal plane (roof surface)

and the areas enclosed by the cone sheath can be considered protected areas. If the height of the roof object to be protected is known, then this calculation can be used to determine the protection area of the air-termination rod or this conversion can be used to determine the required air-termination rod length.

$$r_z = (h_1 - z) \times \tan(\alpha)$$

- α** Protective angle
- 1** LPZ 0_A: Danger posed by direct lightning strikes
- 2** LPZ 0_B: Protected from direct lightning strikes but at risk
- 3** h_1 : Air-termination rod height
- 4** r_z : Radius of the protected area
- 5** Z: Height of the protected area

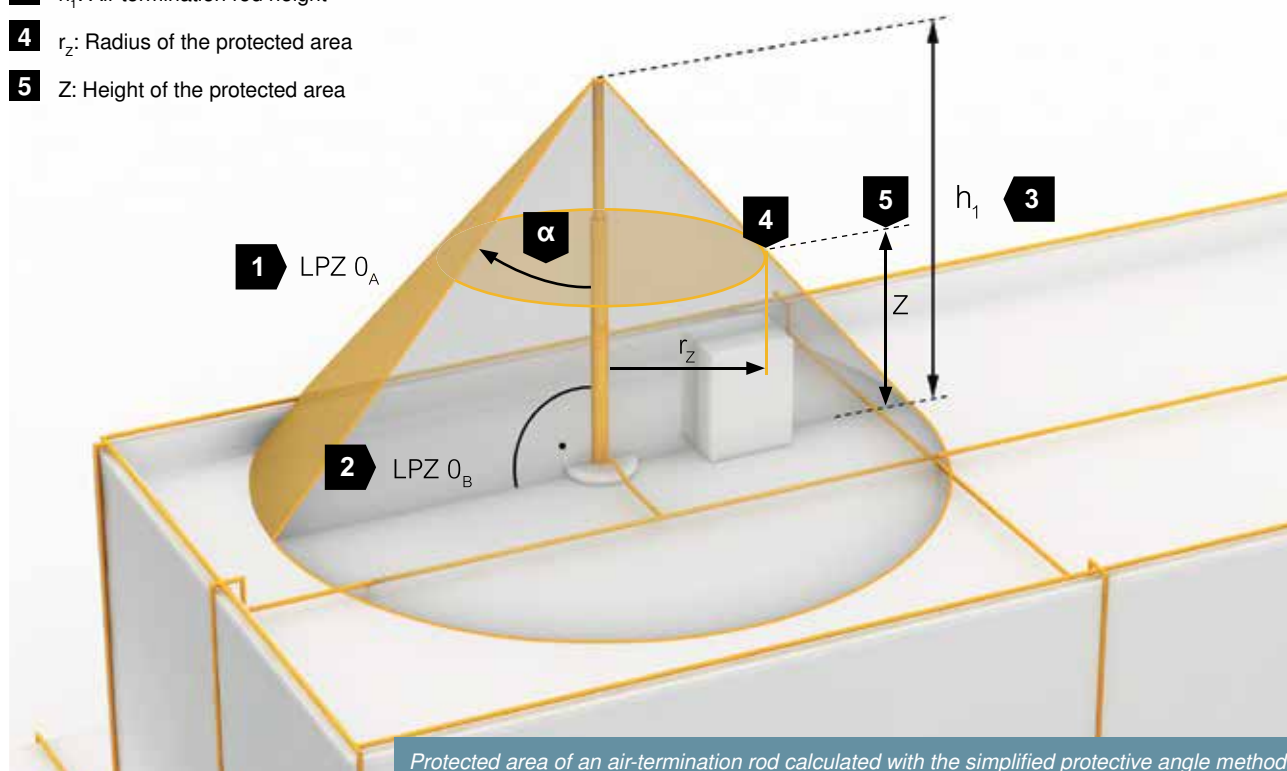

| Lightning protection class | Protection angle α for air-termination rods to 2 m length |
|----------------------------|--|
| I | 70° |
| II | 72° |
| III | 76° |
| IV | 79° |

Protective angle based on lightning protection class according to VDE 0185-305-3 (IEC 62305-3) for air-termination rods up to 2 m in length



Roof structures with multiple air-termination rods

If you use several air-termination rods to protect an object, you must take into consideration the penetration depth between them. For a brief overview, see the table below or, to calculate the penetration depth, use the following calculation:

$$p = r - \sqrt{r^2 - \left(\frac{d}{2}\right)^2}$$

- p** Penetration depth
- r** Radius of rolling sphere
- d** Distance of air-termination system

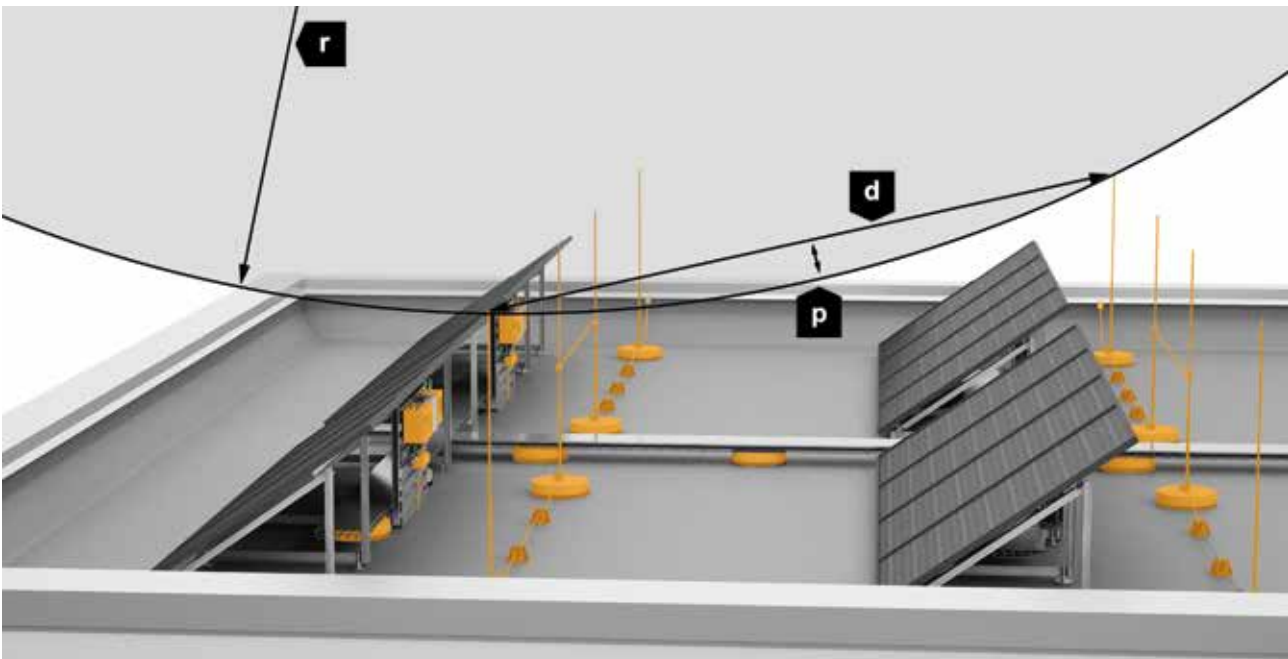

| Distance of air-termination system (d) in m | Penetration depth, lightning protection class I Rolling sphere: r=20 m | Penetration depth, lightning protection class II Rolling sphere: r=30 m | Penetration depth, lightning protection class III Rolling sphere: r=45 m | Penetration depth, lightning protection class IV Rolling sphere: r=60 m |
|---|---|--|---|--|
| 2 | 0.03 | 0.02 | 0.01 | 0.01 |
| 3 | 0.06 | 0.04 | 0.03 | 0.02 |
| 4 | 0.10 | 0.07 | 0.04 | 0.04 |
| 5 | 0.16 | 0.10 | 0.07 | 0.05 |
| 10 | 0.64 | 0.42 | 0.28 | 0.21 |
| 15 | 1.46 | 0.96 | 0.63 | 0.47 |
| 20 | 2.68 | 1.72 | 1.13 | 0.84 |

Penetration depth (p) according to the lightning protection class according to VDE 0185-305 (IEC 62305)

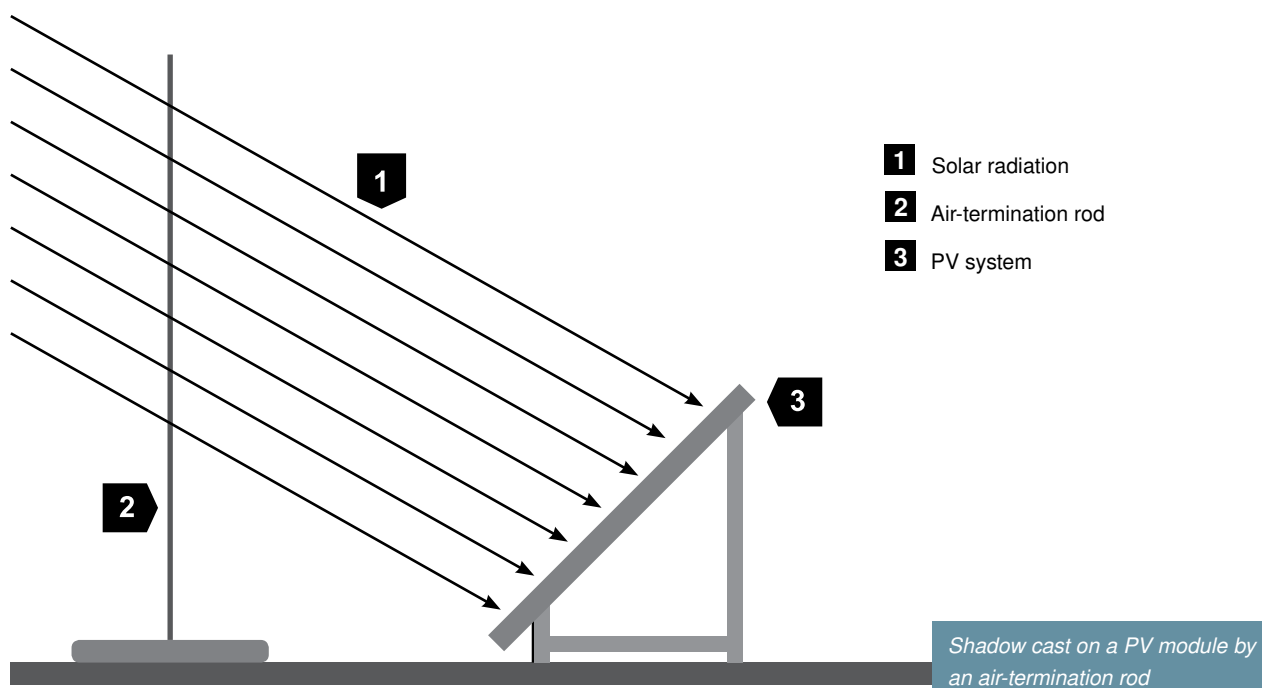

Avoiding shade from the lightning protection system

The correct position of the air-termination rods should ensure so that there is no shading of the PV modules. This can cause performance reductions of the whole string. For this reason, an air-termination rod must be

at least 108 x diameter from the PV module (DIN EN 62305-3 Suppl. 5). Please note that the PV system must remain in the protection area of the air-termination rod.

| Diameter of the air-termination system (m) | Distance between the air-termination system and the PV module (m) |
|--|---|
| 0.008 | 0.86 |
| 0.010 | 1.08 |
| 0.016 | 1.73 |

Minimum distance from the air-termination systems, to avoid a core shadow

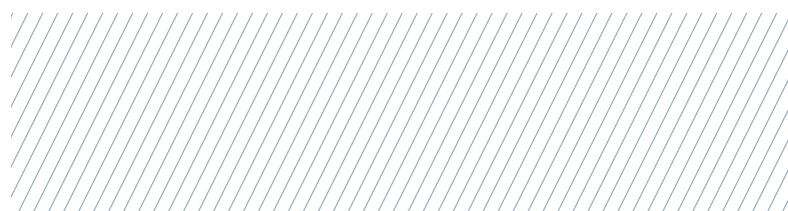



The safe solution: OBO isCon®

The separation distance can be maintained safely using the high-voltage resistant, insulated isCon® system from OBO. The insulated isFang air-termination systems with the isCon® conductor are tested according to VDE V 0185-561-8 (IEC TS 62561-8) and, with correct planning, minimise shadow. This increases the cost-effectiveness of the entire system.

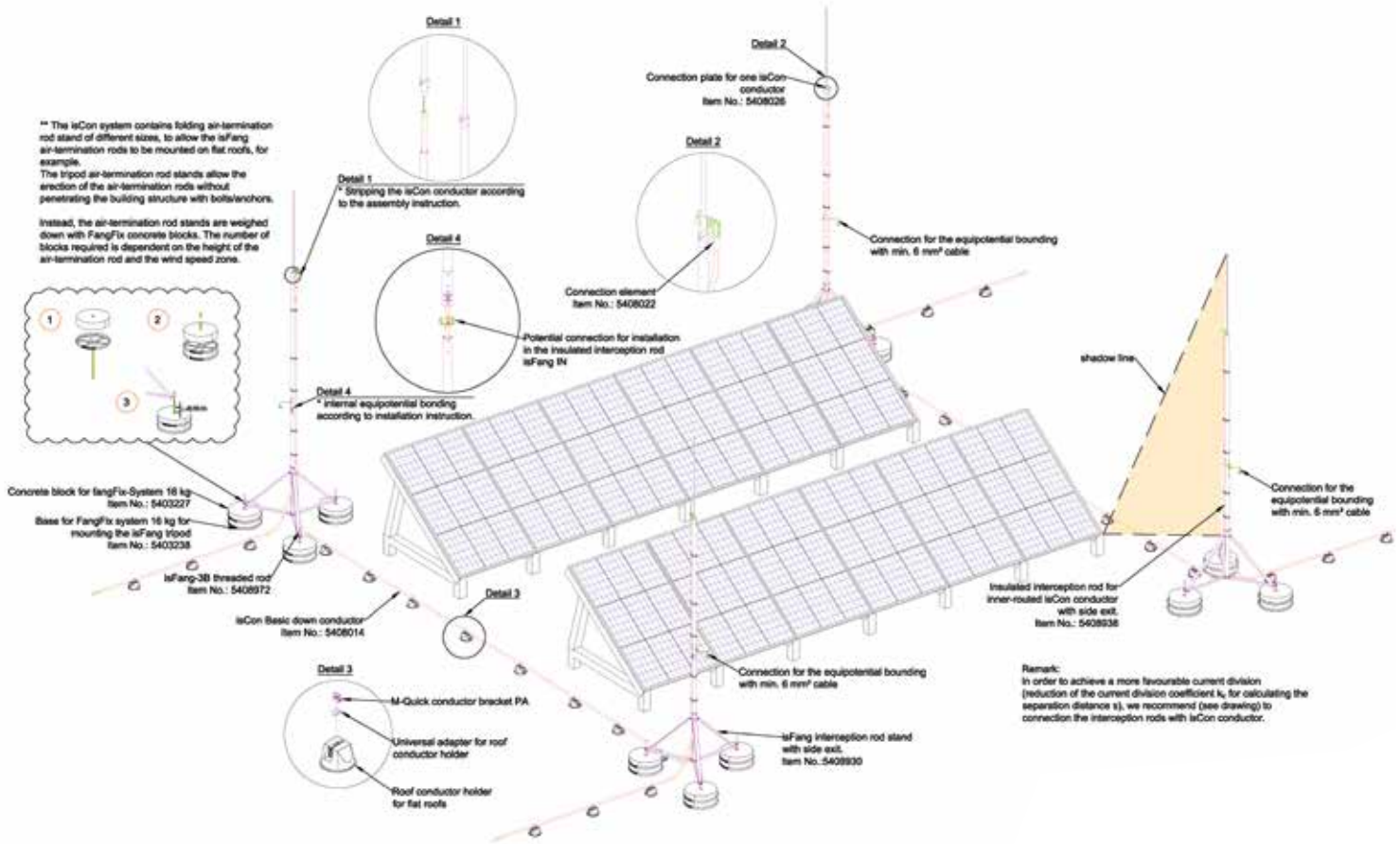

Planning sample of an insulated lightning protection system with isCon®

Selection of protection measures

According to DIN EN 62305-3 Suppl. 5 (VDE 0185-305-3 Suppl. 5):2014-02

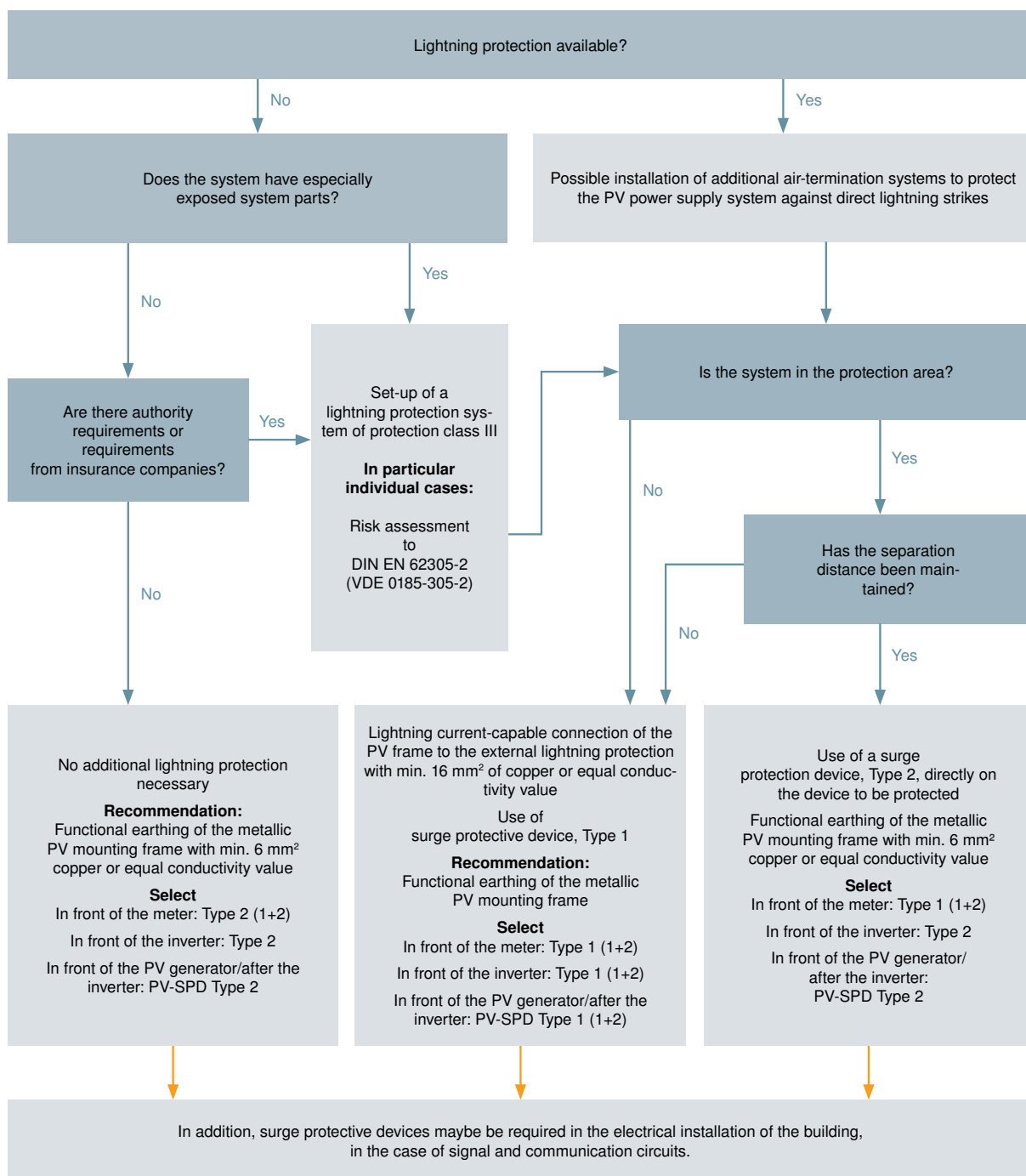

Relevant Standard

- IEC 62305-1 to -4

*This data makes no claim to completeness!
Please observe your national, local and statutory requirements.*



Protection in every direction

There are always two sides to the surge protection of PV systems. Both on the direct current side (DC) and on the alternating current side (AC). Surge voltages can be coupled into the system for all kinds of reasons and, for example, damage the inverter. OBO surge protection reliably protects every possibility. Existing data cables can be safely included in the equipotential bonding using suitable protection devices.



The entire range

OBO's surge protection programme is set up in modules and offers solutions for almost all application cases:

- Lightning arresters
- Combined arrester
- Surge protection for information and data technology
- Combination and surge arrester for photovoltaics, DC side
- Complete system solutions, terminated and pre-mounted in the housing

The ready-made photovoltaic systems for the most common requirements are particularly useful, as they demand minimal installation only. Do you require special solutions, such as insulators or fuses? Then please get in touch with us.



Fundamental for effective lightning protection

In Germany, for example, a foundation earth electrode complying to DIN 18014 must be installed for new buildings with on-roof PV systems without a lightning protection system. In the case of on-roof PV systems with a lightning protection system, the requirements of IEC/ EN 62305-3 must be taken into account (earthing resistance $< 10 \text{ Ohm}$). With open space PV systems, the requirements of IEC/EN 62305-3 must also be taken into account. Here, a distinction between two earthing types must be made.

Earthing systems, Type A

Type A earthing systems include, for example, screw and ram foundations, if they correspond to the requirements of IEC/EN 62561-2. Not only a minimum cross-section must be maintained, but also mechanical and electrical properties.

Earthing systems, Type B

Plate and strip foundations are appropriate Type B earthing systems. According to IEC/EN 62305-3 they have a reduced earth impact and should be expanded using additional earthing measures such as grid earthers (20 m x 20 m) or earth rods.

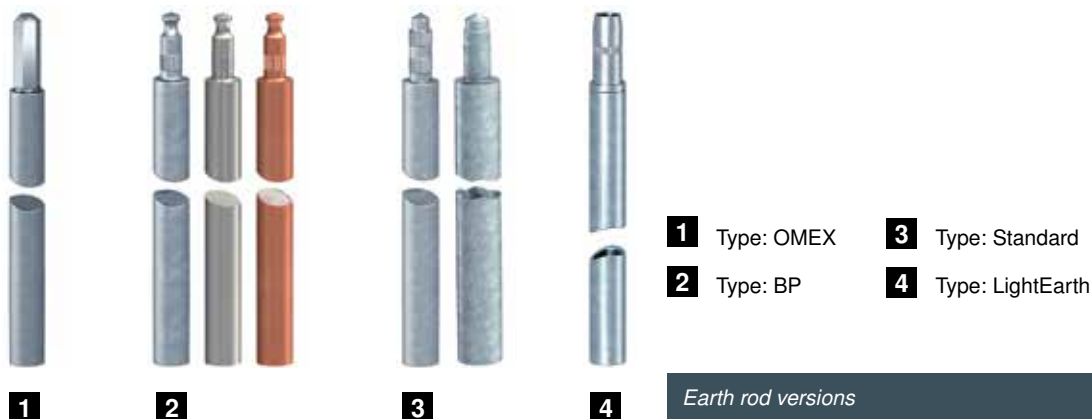

For both cases, OBO's portfolio contains suitable earth rods of Ø 20 mm or Ø 25 mm and wires of Ø 10 mm, as well as strips of various dimensions, such as 30 x 3.5 mm or 40 x 4 mm.

In the case of foundations with reinforcement steel, a tin-plated or copper-plated earther in the earth is not permitted. A high-alloy stainless steel with a molybdenum content of at least 2%, such as those in the material nos. 1.4401, 1.4404 or 1.4571, must be used. This is primarily neutral towards other, more or less precious materials, thus guaranteeing a high system availability.

Functional earthing of metallic substructures

To guarantee functional earthing of metallic substructures or module underframes, VDE 0185-305-3, Supplement 5/ IEC/EN 62305-3, distinguishes between the following situations:

| Situation | Minimum cross-section, copper functional earthing |
|---|---|
| PV system without lightning protection system or PV system with lightning protection system and the separation distance is maintained | 6 mm ² |
| PV system with lightning protection system and the separation distance is not maintained | 16 mm ² |



Insulated lightning protection to maintain the separation distance

Planning the distance. Increasing the protection.

The physical distance of a PV facility to the external lightning protection system should be maintained as much as possible, in order to protect it. If this is not possible due to local circumstances, then the necessary distance may be reduced, if the system is included in the external lightning protection system or an insulated system is being created, e.g. with the high-voltage-resistant, insulated isCon[®] conductor.

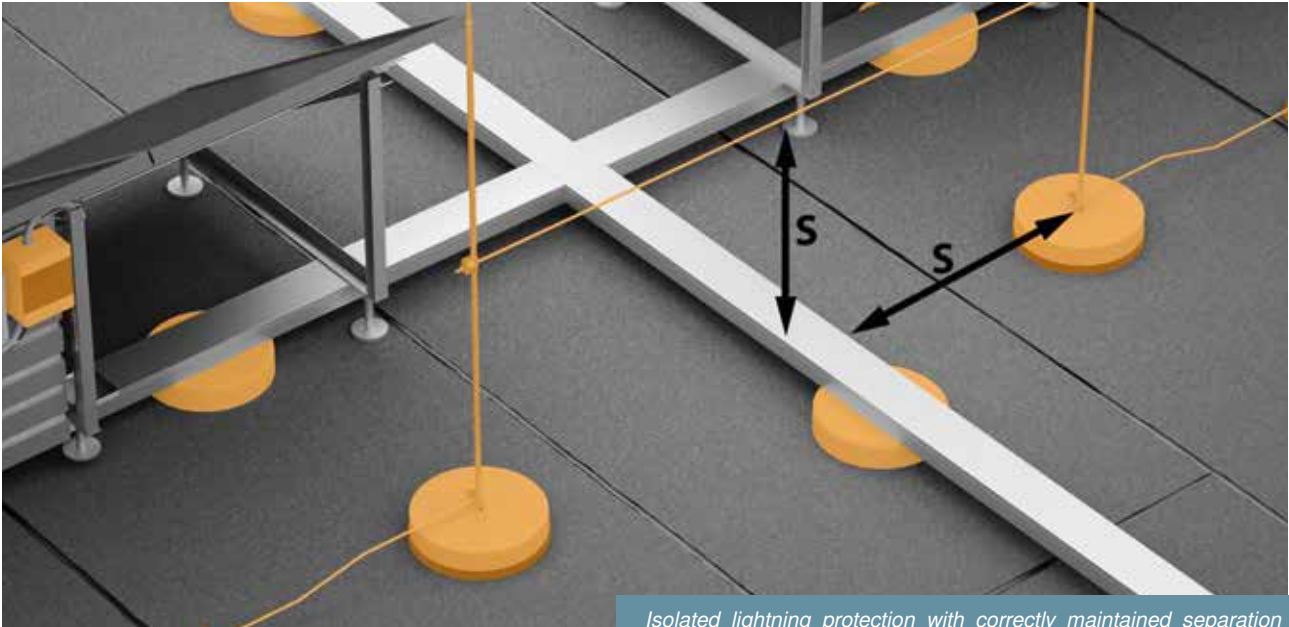

Isolated lightning protection with correctly maintained separation

The decisive factor: The separation distance (s)

If there is an adequate distance between the conductor passing from the lightning current and the metallic building parts, the risk of sparking is practically non-existent. This distance is described as the separation distance (s).

The separation distance (s) does not prevent inductively coupled surge voltages!

$$s = k_i \frac{k_c}{k_m} L(m)$$

Calculating the separation distance

| | |
|----------|--|
| k_{is} | Dependent on the selected protection class of the lightning protection system |
| k_c | Dependent on the (partial) lightning current that flows in the conductors |
| k_m | Dependent on the material of the electrical insulation |
| L (m) | Vertical distance from the point at which the separation distance (s) is to be calculated up to the closest point of the equipotential bonding |

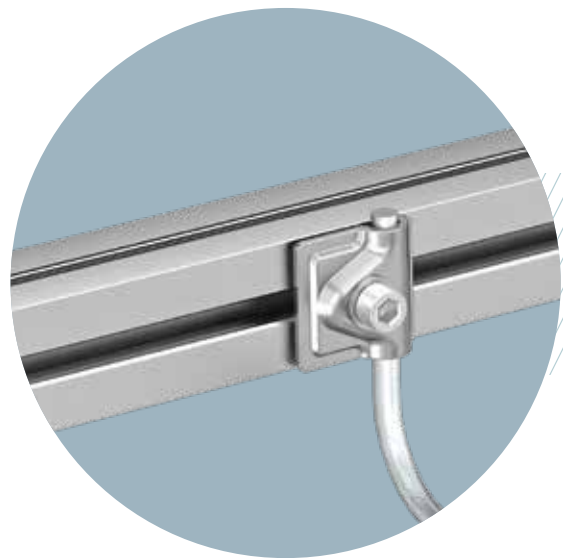

Lightning protection equipotential bonding system on PV mounting system



Lightning protection conductor on a rainwater downpipe



Direct connection of the PV mounting frames to the lightning protection

If the separation distance cannot be maintained

If the separation distance according to IEC/EN 62305-3 cannot be maintained for construction reasons, then the PV system must be connected to the lightning protection system using tested components with 16 mm² CU or 25 mm² aluminium.

Lightning protection components for connection must be tested according to IEC/ EN 62561-1. In these cases, Type 1 (class I) surge protective devices or combination arresters of Type 1+2 (class I+II) are required on the DC side, as lightning currents cannot be managed within buildings.

The necessary lightning protection equipotential bonding achieved in this way connects all the metallic and electrically conductive components of the system, including the earthing system, with the standardised lightning protection system. According to IEC/ EN 62305-3, -4, surge protective devices (SPDs) of Type 1 (class I) or combination arresters of Type 1+2 (class I+II) must be used for the cables running into the building. This applies both on roofs and on the ground, and for the AC and the DC side of the PV power supply system.



SPD Type 1+2 for the PV DC side



Metallic building components and external lightning protection

A separation distance does not have to be observed in buildings with cross-connected, reinforced walls and roofs or with cross-connected metal facades and metal roofs. Metallic components with no conductive lead into the building to be protected, and whose distance to the conductor of the external lightning protection system is less than one metre, must be connected directly to the lightning protection system. These include, although are not limited to, metallic railings, doors, pipes (with non-flammable and/or explosive contents) and facade elements.



Reliable connections. Easy installation.

Cables outside the building are particularly exposed to the weather. Rain, snow, heat, UV radiation and wind continually attack the PV system. OBO cable support systems combine the best possible protection, easy and fast to install. Our product range comprises closed cable tray as well as wide span tray and mesh cable tray systems. Using smart details, such as the mounting adapter, you can fix mesh cable trays to the OBO FangFix concrete blocks easily. The covers are secured to the flat roof by tightening straps.

Cable support systems: Quickly mounted and safe

- Cable trays
- Mesh cable trays
- Cable ladders
- Vertical cable ladders
- Suspended supports
- Wall and support brackets

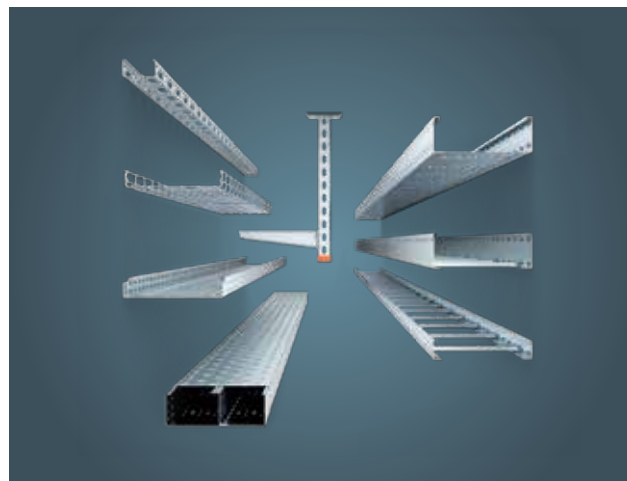

Cable shielding

The passive shielding of cables with OBO cable support systems with covers permits attenuation of up to 60 dB. This means that electronic system components are protected against electromagnetic interference, and economic losses through failure or damage are prevented.

Area shielding

Direct and local lightning strikes create a magnetic field which causes induced currents in electrical and electronic systems. Professional cable routing with the OBO TrayFix systems or optimised cable shielding, for example with EMC-tested cable support systems from OBO, can, under certain conditions according to IEC/ EN 62305-4, reduce the necessary surge protection measures.



Strain relief for vertical cable routing

When cables are routed vertically, appropriate strain relief is installed. Our product range comprises vertical ladder systems with various profiles for direct wall mounting, for free-standing mounting or mounting on existing steel structures.



Perfect protection in buildings

In buildings, cables are also subject to mechanical loads, which, in the worst-case scenario, can lead to the failure of the system. The combination of the OBO products creates reliable protection of cabling, from the roof through to the inverter. Wall and ceiling ducts of different dimensions are complemented with appropriate fittings. Plastic and metal cable and pipe fastening systems and clips protect small cable volumes and individual cables. In this way, you can protect the system against failure through torn or worn-through cables for decades to come.



For tidy cable routing in buildings:

- Wall and ceiling duct
- Cable and pipe fastening systems made of plastic and metal
- Screw-in and knock-in systems
- Rail systems



Metal pipe systems: The first choice for protection under tough conditions



Pre-marked openings to minimise condensation through temperature variations

Precautions for water drainage

According to DIN VDE 0100-520 (Erection of heavy current systems for rated voltages of up to 1,000 V) "Measures must be taken to remove water, as water or water condensation can occur within cable systems."

Protection against sunlight and high temperatures

Strong UV radiation can cause damage and destruction to plastics. Electrical devices generate heat through loss of power. In conjunction with high ambient temperatures and direct sunlight, the internal temperature can increase. Based on the actual loads, the installation engineer may need to perform additional measures. For example, the installation must be protected by an additional roof against direct sunlight and loads from rain and snow.



Protected bridging of the fire wall using fire protection duct with internal coating

Cable routing bridging fire walls

Combustible cables may not be run over fire walls without fire protection devices. As a fire could spread to the neighbouring roof area.

Two solutions are available to bridge fire walls in a protected manner, thus preventing fire spread:

- Routing of the PV cables in extremely robust PYROLINE® PLMR stainless steel duct
- Wrapping of the cable bundles with the flexible, weatherproof PYROWRAP® Wet FSB-WB cable bandage

When there is a fire, the substances forming an insulation layer, which are contained in both solutions, foam up and prevent the spread of fire via the PV cables.



Fire protection bandage to prevent fire spread

Insulated lightning protection within building insulation

If isCon® cables are routed within a composite heat insulation system, then they may penetrate so-called fire locks made of non-combustible substances. If there is a fire, the fire locks may even fail. Here, the PYROWRAP® Wet FSB-WB cable bandage is again used, which prevents the spread of the fire. Whilst the insulation burns and openings are created, the insulation layer creator foams them up again. This safely prevents a chimney effect via the isCon® conductor.

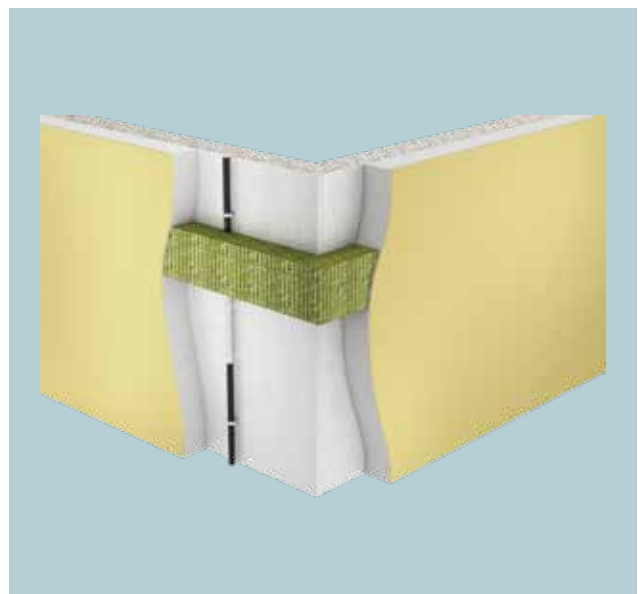

Fire protection bandage to prevent fire spread via isCon® within building insulation



Routing PV cables within buildings

In some cases, the cables carrying direct current must still be routed through the building up to the inverter. If the installations are in escape and rescue routes, then the PV DC cables must be routed in encapsulated form. The OBO PYROLINE® Sun PV fire protection ducts are suitable for this. They are made of non-conductive lightweight concrete and fulfil the construction requirements as installation ducts with proven fire protection. In addition, the fire protection duct fulfils the requirements for fireproof and contact-proof installations. This also offers additional protection for the rescue services against electric shocks during extinguishing work.

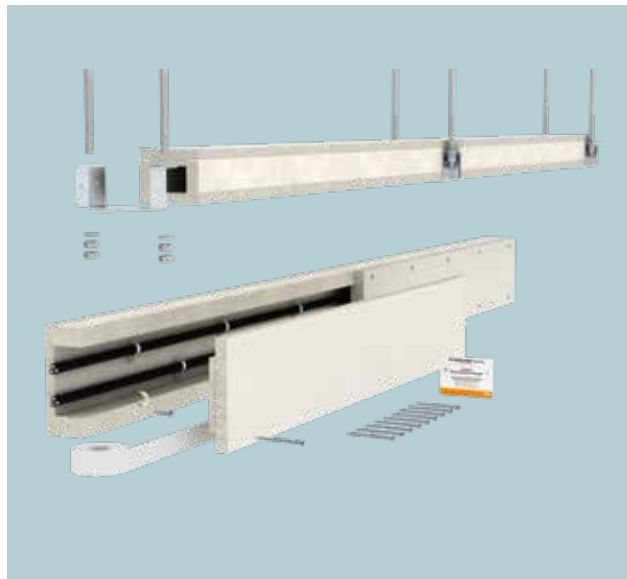

PYROLINE® Sun PV fire protection ducts for cable routing in escape and rescue routes

Relevant signs

At the transition point of the electrical system, e.g. house connection box, main distribution, requires the attachment of the standardised information sign/fire brigade sign. The fire brigade can recognise the PV system through the identification and fireproof routing of the energised DC cables.

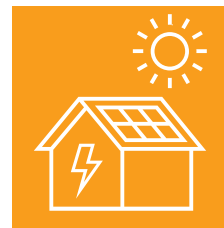

Construction regulations

- EN 13501-1/-2, DIN 4102-1/-2 Fire classification of construction products and building elements

The national and regional construction regulations must be observed with regard to the use of construction products. These include, for example, the state construction regulations in Germany, VKF regulations in Switzerland and OIB directives in Austria.

Cable bracket for Rd 8 mm, through-way Ø 5 mm

- With M6 internal thread or Ø 5 mm through-way hole
- Made of rustproof stainless steel (V2A)



ALU variable earthing connector

- For T, cross and parallel connections

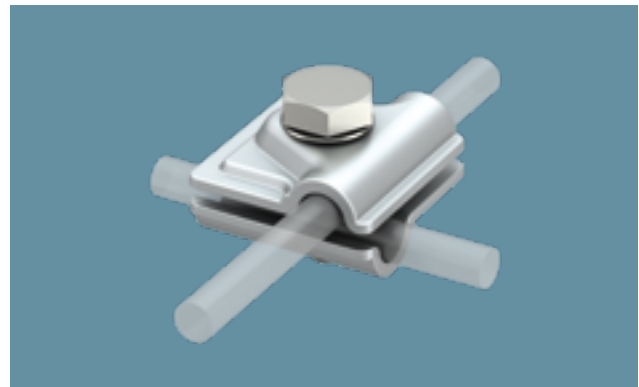

Pipe air-termination rod, tapered

- Suitable for wind loads according to Eurocode 1



isCon® conductors, black

- High voltage-resistant, insulated conductor
- To maintain the separation distance according to IEC 62305 (VDE 0185-305-3)
- Tested according to IEC/EN 62561-1 (VDE 0185-561-1) with H1/150 kA
- Various versions available



Connection element for installation in the isFang IN insulated air-termination rod

- Screw-in termination of the connection for the isCon® conductor
- Connection and routing of the conductor in the insulated air-termination rod



isCon® connection elements

- Screw-in termination of the connection for the isCon® conductor
- Including heat-shrinkable sleeve and hexagonal connection



Insulated air-termination rod for internally routed isCon® conductor with side exit

- For mounting on the building structure with isFang support
- Suitable for wind loads according to Eurocode 1

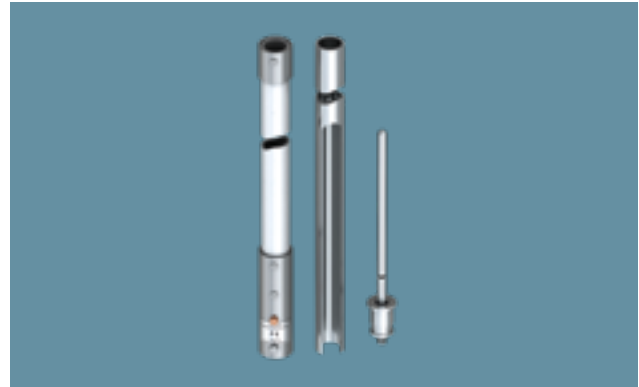

isFang air-termination rod stand

- Installation of free-standing air-termination rods and insulated air-termination rods with 40 mm diameter
- Roof slope up to max. 5 degrees

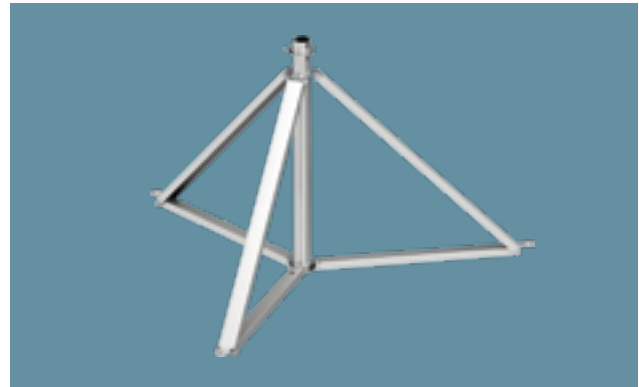

Rod holder, 16 mm

- For Rd 16 air-termination and earth entry rods
- With M8 internal thread or Ø 7 mm through-way hole

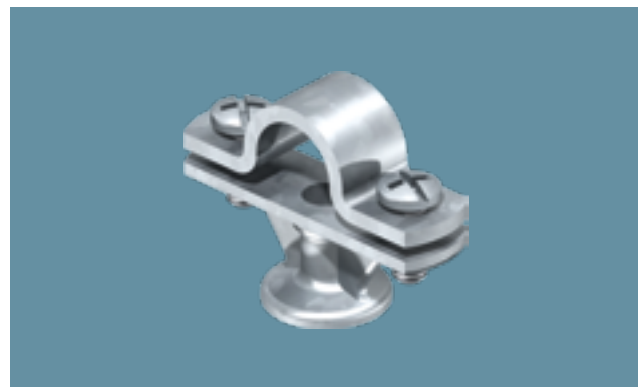

Sloping roof system



Flat roof system



Free-standing system

TD-2D-V combination protection device for VDSL systems

- Low protection level at a high current load
- "Push-in" terminals for rapid installation



Surge protection for high-speed networks up to 1 GBit

- Support of Power over Ethernet ++ (PoE++/4PPoE) up to 1 A according to IEEE 802.3
- Earthing via DIN rail or connection cable



PV system solution, type 2, with MC4 connector for IV with 2 MPP trackers, 1,000 V DC

- Low DC protection level: < 4.0 kV (Uoc max = 1,000 V DC with V20-C/0-500PV)
- One PV string input (MC4 plug connector) on an MPP-IV input, up to 30 A DC per terminal



V50 combination arrester and V20 surge arrester

- For lightning protection equipotential bonding
- Modular plug-in arrester



PV complete block 1,000 V DC/1,500 V DC

- Lightning protection equipotential bonding according to IEC 62305 (VDE 0185-305)
- Surge protection according to IEC 60364-7-712 (VDE 0100-712)
- Arresting capacity up to 12.5 kA (10/350) and 40 kA (8/20)



Surge Controller V20 2-PH-1000

- Arresting capacity up to 40 kA (8/20) per pin
- Low DC protection level: < 4.0 kV and Uoc max = 1,000 V DC



LightningController MCF25-NAR-TNC/ MCF38-NAR-TNC

- Lightning current arresting capacity up to 25/38 kA (10/350), 3-pin
- Fulfils the requirements of VDE 0100-534 (IEC 60364-5-53)



LightningController MCF30-NAR-TT/MCF50-NAR-TT

- Fulfils the requirements of VDE 0100-534 (IEC 60364-5-53)
- Follow current quenching up to 50 kA and max. pre-fuse up to 160 A gL/gG
- Spark gaps for use in the pre-meter area according to VDE-AR-N 4100



BP earth rod

- Very good contacting properties through soft metal inlay in the drill hole
- With spigot and drill hole for arrangement



Connection clip for earth rod, universal

- Mounted with two M10 x 30 hexagonal bolts and two M10 hexagonal nuts
- Suitable for connecting round conductors Rd 8-10 or flat conductors up to FL 40



Round conductor, stainless steel

- RD 10-V4A for applications in the earth



Cross-connector for stainless steel round and flat conductors

- Mounted with two M8 x 20



Equipotential busbar for outside installation, metal base plate

- Lightning current carrying capacity 100 kA (10/350)
- Polystyrene cover hood; colour: Black, UV-resistant
- Steel base plate, zinc-iron surface

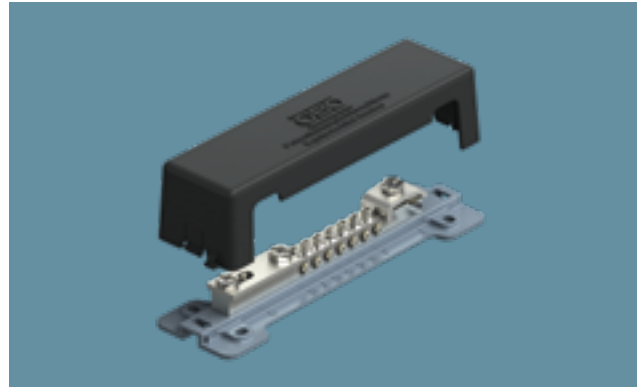

BigBar equipotential busbar for industrial areas

- With spring washer (DIN 137) for protecting screws against self-loosening
- Complete with insulation feet, anchors and screws for wall mounting

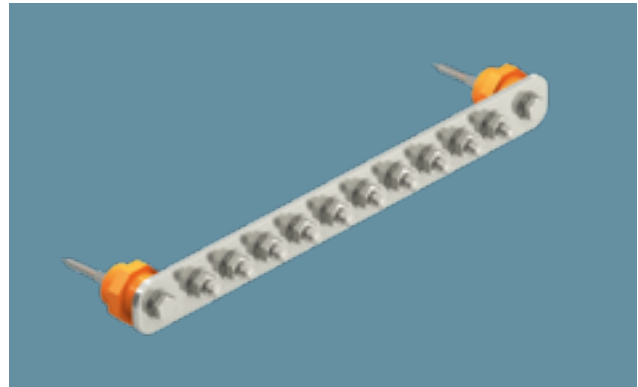

Quick connector, cover Rd 8-10 mm VA

- For round conductor Rd 8-10
- Suitable for M10 screws

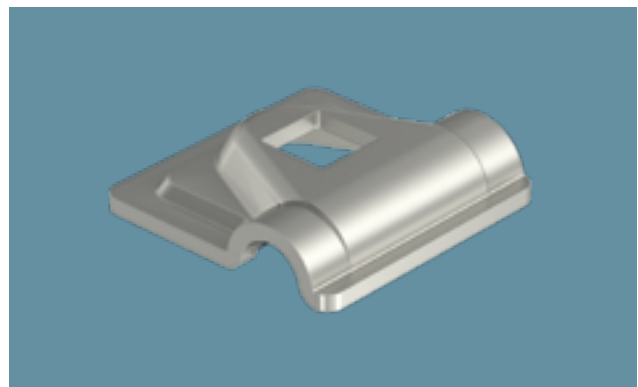

Quick connector, cover Rd 8-10 mm

- For round conductor fastening RD 8-10
- Suitable for M10 screws

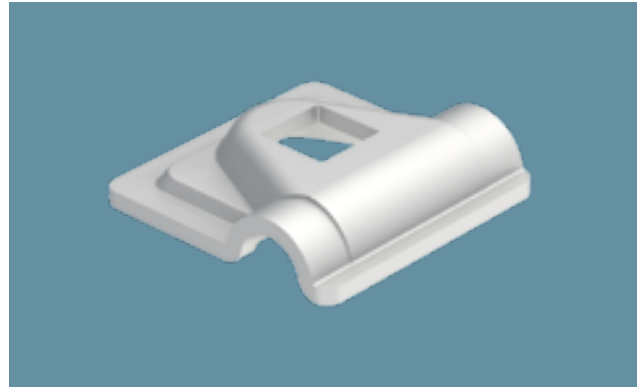

Bridging cable

- With aluminium cable shoes
- Made of flexible, insulated copper cable 16 mm²
- Suitable for use outside or in rooms



MS4141 mounting rail, slot 22 mm, FT, perforated

- Heavy-duty C profile rail for individual installation of support structures
- Can also be used for cable routing, in conjunction with clamp clips with U base

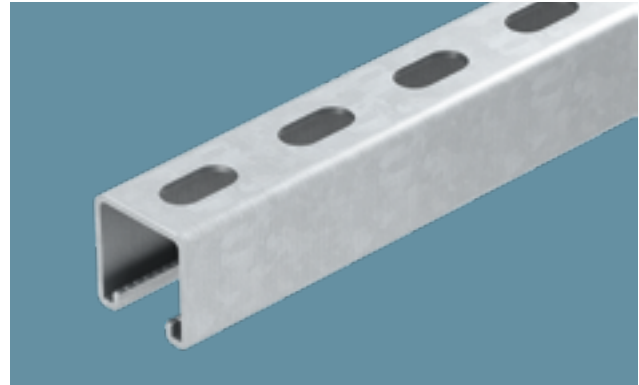

T160 junction box, plug-in seal, raised cover

- Junction box according to DIN EN 60670. Flame-resistant according to DIN EN 60695-2-11, test temperature 650 °C
- Rectangular shape with plug-in seals at the sides and knock-out entries in the base
- Manufactured from halogen-free materials

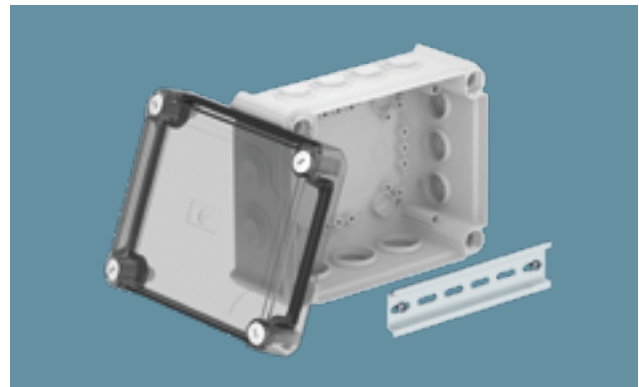

Quick pipe, light grey

- Open plastic Quick pipe pipe for surface-mounted routing of M16/M20 cables
- Can be used in the temperature range of -25° to $+60^{\circ}$ C
- Toolless closing and opening through turning in the clip

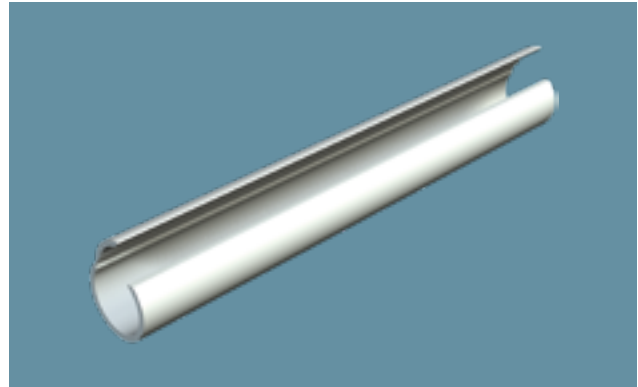

165 MBG... roof cable holder for flat roofs, black, with concrete

- Closed shape with base
- With double cable bracket
- Filling weight 1 kg (frost-resistant concrete)

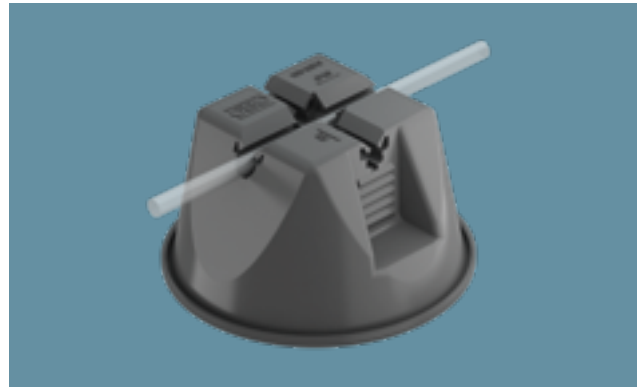

Mesh cable tray adapter for roof cable holder

- Adapter for mesh cable trays, type GR-Magic®, with 50 mm or 20 mm grid width
- For fastening on type 165 MBG 8-10
- Toolless mounting

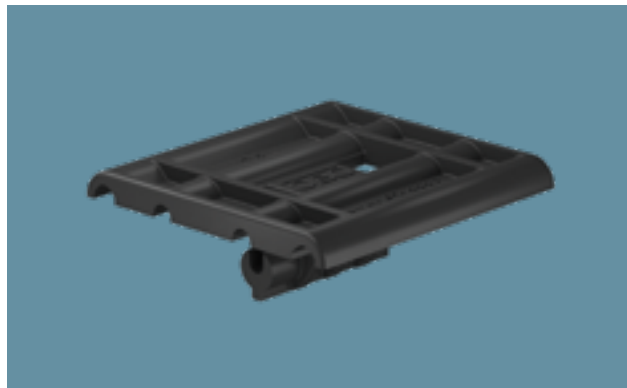

Stand – TrayFix Set 16 L

- Mounting system for fastening mesh cable trays with the FangFix block
- Matched to OBO MKSM and SKSM cable tray systems
- Matched to OBO mesh cable tray systems with a minimum width of 100 mm

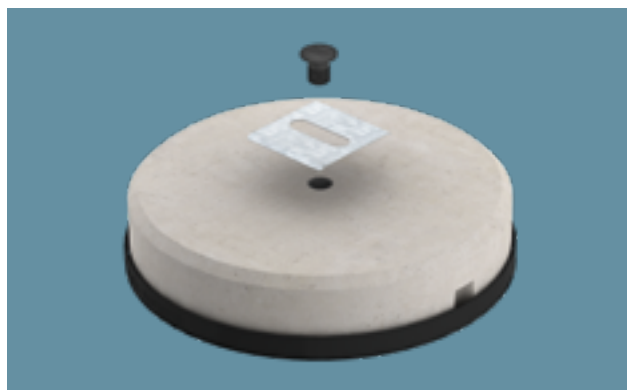

Stand – TrayFix Set 10 S/16 S

- Mounting system for fastening mesh cable trays with the FangFix block
- Matched to OBO mesh cable tray systems with a minimum width of 100 mm
- Set consisting of a TrayFix mounting adapter and concrete block, incl. base for FangFix system 10 kg/16 kg



Sloping roof system



Flat roof system



Free-standing system

GR-Magic® 55 FT mesh cable tray

- Magnetic shield attenuation without cover 15 dB, with cover 25 dB

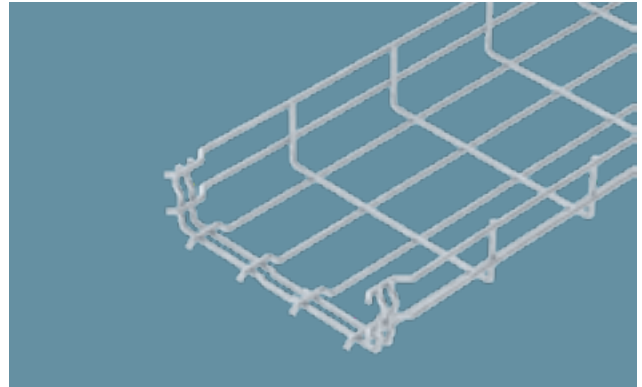

RKS-Magic® 60 FT cable tray

- Cable tray with integrated quick fastening system
- The usable length of the cable tray is 3,000 mm
- The perforation for the direct threaded rod suspension has a diameter of 11 mm

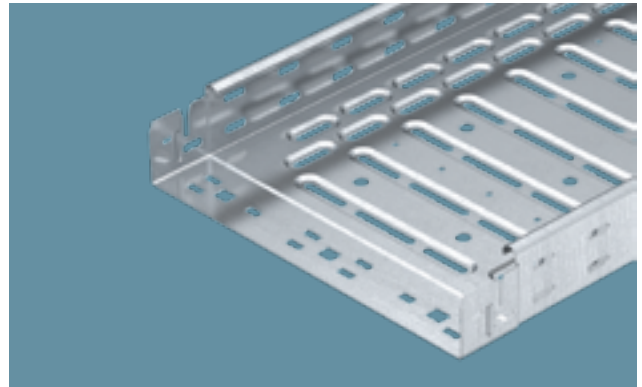

Complete set for external applications

- Complete set to surround cable bundles or cable support systems without covers
- The sets each contain four sections of the weather-resistant PYROWRAP® Wet cable bandage
- Length 550 mm // Width 380/880 mm

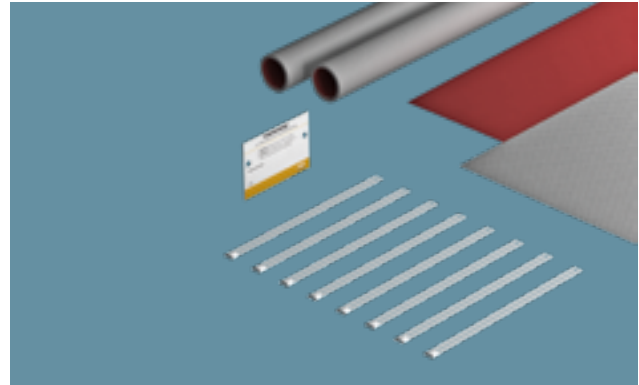

PYROLINE® fire protection duct

- Fibreglass lightweight concrete
- Water and frost-resistant



Round conductor, stainless steel

- Can be used as earthing conductor
- RD 10-V4A for applications in the earth



OBO Bettermann Holding GmbH & Co. KG

P.O. Box 1120
58694 Menden

Customer Service

Tel.: +49 (0)2373 89-1700
Fax: +49 (0)2373 89-1238
export@obo.de

www.obo-bettermann.com

© OBO Bettermann 09/2022 EN

Building Connections

