

Energy and data at your fingertips –  
with the Deskbox from OBO

**OBO**  
BETTERMANN



**THINK CONNECTED.**

# Perfect connection to energy and data infrastructure



## The OBO Deskbox makes life easy

High-quality material, slim design and variable installation options: The new generation of OBO Deskboxes can prove themselves both in the standard and special versions through their appearance and versatility. The box, made of high-quality aluminium, can be positioned anywhere on the workplace, thus offering a range of design options.



## Pre-terminated versions



Deskbox, freely erectable at the workstation



Deskbox without fastening material, combinable with the different fastening types



Deskbox for mounting on the tabletop







OBO can offer various pre-terminated and ready-for-connection versions of the Deskbox for standard workplace requirements – including network connection cables.



## Deskboxes, individually configured

### Selection equipment with energy technology

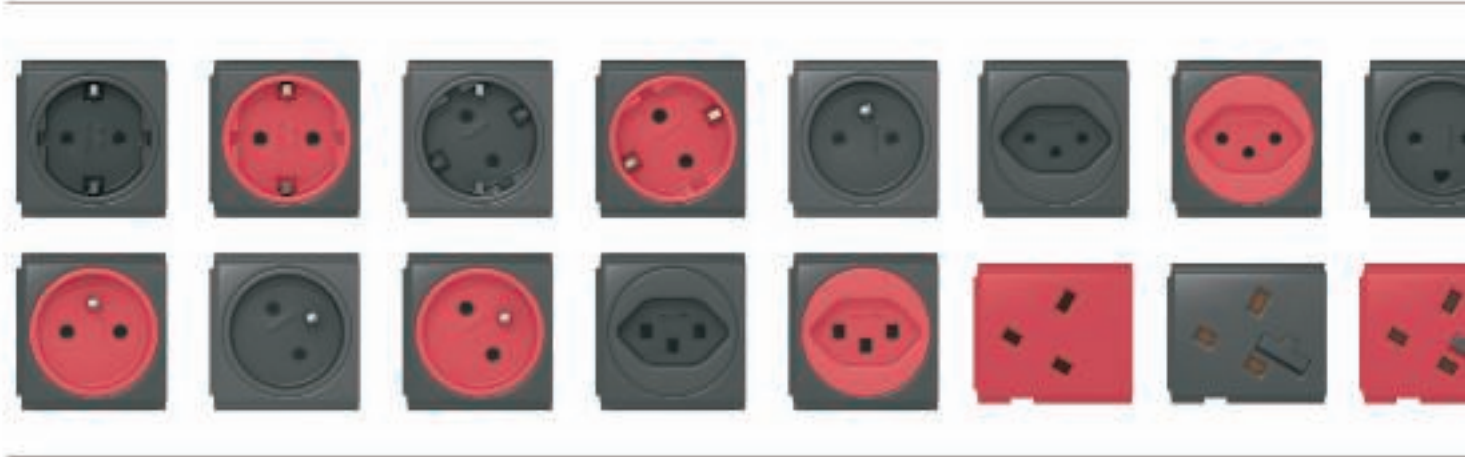

### Select the fastening type and accessories



### Select equipment with data technology, switching and connection solutions





Alternatively, the train profile can be equipped according to your requirements. A comprehensive range of installation units and accessories are available for this. These range from country-specific sockets, through data technology and protection modules, right up to multimedia connections. The individual Deskbox is then supplied as a tested and ready-to-connect unit with a network connection cable.

Please note that the equipment components cannot be ordered individually.

You can find the configuration form at [www.obo.de](http://www.obo.de).



# Ready-for-connection Deskbox



## Deskbox with 3 sockets

Type	Version	Pack	Weight	Item no.
		Units	kg/100 pc.	
<b>DB-5A3 D3S</b>	Housing, silver anodised	1	66.000	<b>6116 93 0</b>

**Al** Aluminium **EL** Anodised /pc.

Ready-for-connection Deskbox with connection cable, cable outlet on the left housing cover, freely erectable.

### Equipment:

- Three protection contact sockets in 0° connection direction, incl. 3.0 m power cable with angular connector CEE 7/7.

Type	Version	Pack	Weight	Item no.
		Units	kg/100 pc.	
<b>DB-1B3 D3S</b>	Housing, silver anodised	1	102.000	<b>6116 93 6</b>

**Al** Aluminium **EL** Anodised /pc.

Ready-for-connection Deskbox with connection cable, cable outlet at the bottom left of the profile with a fastening clamp for tabletop thicknesses of 8 to 40 mm.

### Equipment:

- Three protective contact sockets in 0° connection direction, incl. 3.0 m power cable with angular connector CEE 7/7.

Type	Version	Pack	Weight	Item no.
		Units	kg/100 pc.	
<b>DB-0B3 D3S</b>	Housing, silver anodised	1	66.000	<b>6116 93 9</b>

**Al** Aluminium **EL** Anodised /pc.

Ready-for-connection Deskbox with connection cable, cable outlet at the bottom left of the profile, without fastening material, combinable with the fastening solutions listed in the accessories.

### Equipment:

- Three protection contact sockets in 0° connection direction, incl. 3.0 m power cable with angular connector CEE 7/7.

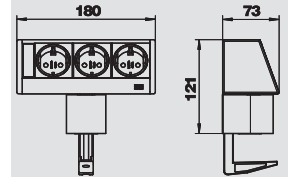
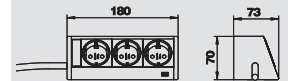

## Deskbox with 3 sockets and data technology connection

Type	Version	Pack	Weight	Item no.
		Units	kg/100 pc.	
<b>DB-5A3 D3S2K</b>	Housing, silver anodised	1	86.000	<b>6116 93 3</b>

**Al** Aluminium **EL** Anodised /pc.

Ready-for-connection Deskbox with connection cable, cable outlet on the left housing cover, freely erectable.

### Equipment:

- Three protective contact sockets in 0° connection direction, incl. 3.0 m power cable with angular connector CEE 7/7.
- Two data technology couplings RJ45 to RJ45, switched 1:1, Cat. 6 shielded.

Type	Version	Pack	Weight	Item no.
		Units	kg/100 pc.	
<b>DB-1B3 D3S2K</b>	Housing, silver anodised	1	122.000	<b>6116 94 2</b>

**Al** Aluminium **EL** Anodised /pc.

Ready-for-connection Deskbox with connection cable, cable outlet at the bottom left of the profile with two fastening clamps for tabletop thicknesses of 8 to 40 mm.

### Equipment:

- Three protective contact sockets in 0° connection direction, incl. 3.0 m power cable with angular connector CEE 7/7.
- Two data technology couplings RJ45 to RJ45, switched 1:1, Cat. 6 shielded.

Type	Version	Pack	Weight	Item no.
		Units	kg/100 pc.	
<b>DB-0B3 D3S2K</b>	Housing, silver anodised	1	85.700	<b>6116 94 5</b>

**Al** Aluminium **EL** Anodised /pc.

Ready-for-connection Deskbox with connection cable, cable outlet at the bottom left of the profile, without fastening material, combinable with the fastening solutions listed in the accessories.

### Equipment:

- Three protection contact sockets in 0° connection direction, incl. 3.0 m power cable with angular connector CEE 7/7.
- Two data technology couplings RJ45 to RJ45, switched 1:1, Cat. 6 shielded.

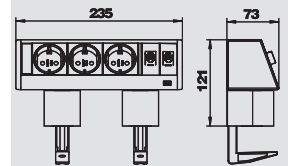
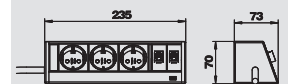



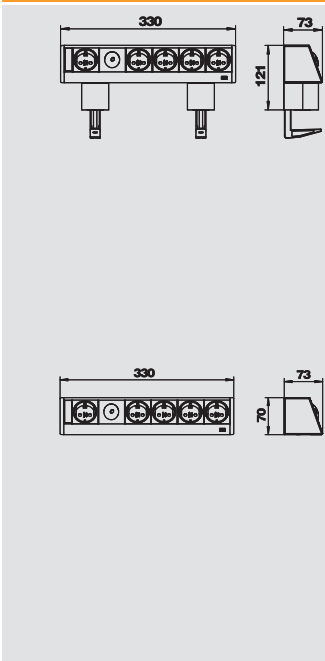

## Deskbox with 1+4 sockets

Type	Version	Pack	Weight	Item no.
		Units	kg/100 pc.	
<b>DB-1B3 D1.4S</b>	Housing, silver anodised	1	157.000	<b>6116 94 8</b>

**Al** Aluminium **EL** Anodised /pc.

Ready-for-connection Deskbox with connection cable, cable outlet at the bottom left of the profile with two fastening clamps for tabletop thicknesses of 8 to 40 mm.

### Equipment:

- Five protective contact sockets in 0° connection direction, of which one socket is for continuous current and four sockets can be switched using a one-way switch (lit in blue), incl. 3.0 m power cable with angular connector CEE 7/7.

Type	Version	Pack	Weight	Item no.
		Units	kg/100 pc.	
<b>DB-0B3 D1.4S</b>	Housing, silver anodised	1	120.000	<b>6116 95 1</b>

**Al** Aluminium **EL** Anodised /pc.

Ready-for-connection Deskbox with connection cable, cable outlet at the bottom left of the profile, without fastening material, combinable with the fastening solutions listed in the accessories.

### Equipment:

- Five protective contact sockets in 0° connection direction, of which one socket is for continuous current and four sockets can be switched using a one-way switch (lit in blue), incl. 3.0 m power cable with angular connector CEE 7/7.

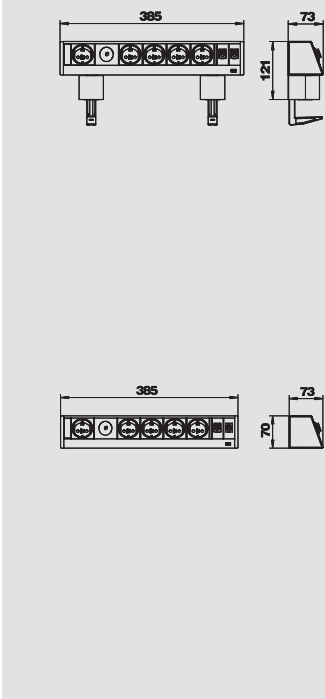

## Deskbox with 1+4 sockets and data technology connection

Type	Version	Pack	Weight	Item no.
		Units	kg/100 pc.	
<b>DB-1B3 D1.4S2K</b>	Housing, silver anodised	1	177.000	<b>6116 95 4</b>

**Al** Aluminium **EL** Anodised /pc.

Ready-for-connection Deskbox with connection cable, cable outlet at the bottom left of the profile with two fastening clamps for tabletop thicknesses of 8 to 40 mm.

### Equipment:

- Five protective contact sockets in 0° connection direction, of which one socket is for continuous current and four sockets can be switched using a one-way switch (lit in blue), incl. 3.0 m power cable with angular connector CEE 7/7.

- Two data technology couplings RJ45 to RJ45, switched 1:1, Cat. 6 shielded.

Type	Version	Pack	Weight	Item no.
		Units	kg/100 pc.	
<b>DB-0B3 D1.4S2K</b>	Housing, silver anodised	1	140.000	<b>6116 95 7</b>

**Al** Aluminium **EL** Anodised /pc.

Ready-for-connection Deskbox with connection cable, cable outlet at the bottom left of the profile, without fastening material, combinable with the fastening solutions listed in the accessories.

### Equipment:

- Five protective contact sockets in 0° connection direction, of which one socket is for continuous current and four sockets can be switched using a one-way switch (lit in blue), incl. 3.0 m power cable with angular connector CEE 7/7.

- Two data technology couplings RJ45 to RJ45, switched 1:1, Cat. 6 shielded.

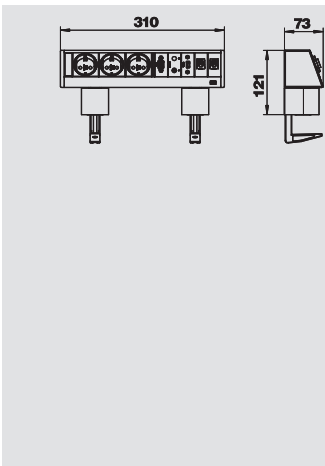

## Deskbox with 3 sockets and data technology and multimedia connection

Type	Version	Pack	Weight	Item no.
		Units	kg/100 pc.	
<b>DB-M1B3 D3S2K</b>	Housing, silver anodised	1	186.000	<b>6116 96 0</b>

**Al** Aluminium **EL** Anodised /pc.

Ready-for-connection Deskbox with connection cable and cable outlet at the bottom left of the profile (power supply) and at the bottom right of the profile (multimedia) with two fastening clamps for tabletop thicknesses of 8 to 40 mm.

### Equipment:

- Three protective contact sockets in 0° connection direction, incl. 3.0 m power cable with angular connector CEE 7/7.

- One VGA 15-pin HDD socket, incl. 3.0 m connection cable with connector.

- One audio jack socket 3.5 mm, incl. 3.0 m connection cable with connector.

- One USB 2.0, type A socket, incl. 3.0 m connection cable with type A connector.

- Two data technology couplings RJ45 to RJ45, 1:1 switched, Cat. 6 shielded.



# Ready-for-connection Deskbox



## Deskbox with 3 sockets and data technology and multimedia connection

Type	Version	Pack	Weight	Item no.
		Units	kg/100 pc.	
<b>DB-M0B3 D3S2K</b>	Housing, silver anodised	1	150.000	<b>6116 96 3</b>

**Al** Aluminium **EL** Anodised /pc.

Ready-for-connection Deskbox with connection cable and cable outlet at the bottom left of the profile (power supply) and at the bottom right of the profile (multimedia), without fastening material, combinable with the fastening solutions listed in the accessories.

Equipment:

- Three protection contact sockets in 0° connection direction, incl. 3.0 m power cable with angular connector CEE 7/7.
- One VGA 15-pin HDD socket, incl. 3.0 m connection cable with connector.
- One audio jack socket 3.5 mm, incl. 3.0 m connection cable with connector.
- One USB 2.0, type A socket, incl. 3.0 m connection cable with type A connector.
- Two data technology couplings RJ45 to RJ45, 1:1 switched, Cat. 6 shielded.



## Fastening clamp

Type	Colour	Version	Pack	Weight	Item no.
			Units	kg/100 pc.	
<b>DBZ-BZ40</b>	Black	Clamping range 8 to 40 mm	1	18.000	<b>6116 97 6</b>
<b>DBZ-BZ75</b>	Black	Clamping range 40 to 75 mm	1	20.000	<b>6116 97 9</b>

/pc.

Fastening clamp for Deskbox mounting on the edge of a table.

Note: For housing widths of 200 mm or more, two fastening clamps are required to mount a Deskbox.

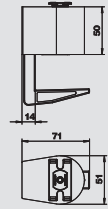

## Stainless steel fastening stand

Type	Pack	Weight	Item no.
	Units	kg/100 pc.	
<b>DBZ-BFE</b>	1	34.000	<b>6116 98 2</b>

/pc.

Stainless steel fastening stand for fixed Deskbox mounting on a tabletop. It is mounted using a drill hole (Ø16 mm) in the tabletop.

Note: Can be used in tabletops of up to 50 mm thickness.

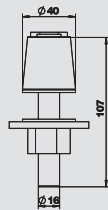

## Fastening set for table mounting

Type	Pack	Weight	Item no.
	Units	kg/100 pc.	
<b>DBZ-BST</b>	1	2.300	<b>6116 98 5</b>

/pc.

Fastening set for fixed Deskbox mounting on the tabletop. It is mounted using a drill hole (Ø10 mm) in the tabletop.

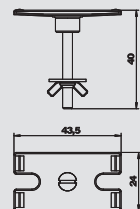

## Flexkanal holder

Type	Colour	Pack	Weight	Item no.
		Units	kg/100 pc.	
<b>DBZ-FLKB</b>	Black	1	1.100	<b>6116 99 1</b>

/pc.

Flexkanal holder for secure connection of a Flexkanal to the Deskbox.

Note: Can only be used for mounting on the tabletop using fastening clamps.

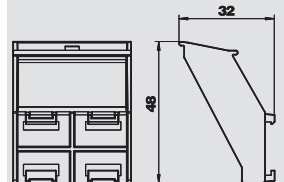

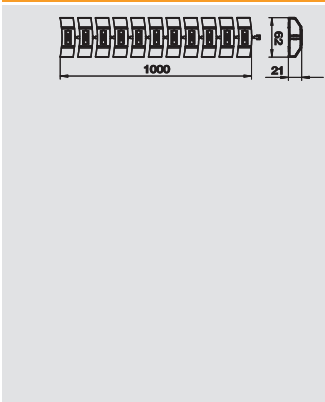

## Flexkanal

Type	Length	Colour	Pack	Weight	Item no.
	mm		m	kg/100 m	
<b>FLK-2K CRW</b>	1000	Cream	1	28.760	<b>6154 92 0</b>
<b>FLK-2K LGR</b>	1000	Light grey	1	28.760	<b>6154 92 2</b>
<b>FLK-2K BL</b>	1000	Ultramarine	1	28.760	<b>6154 92 4</b>
<b>FLK-2K SWGR</b>	1000	Black-grey	1	28.760	<b>6154 93 0</b>



/m

The Flexkanal runs your cables ordered and protected to the desk. It connects the Deskbox with the dado duct or with the floor connection box. When extended, the Flexkanal is 1,000 mm long, 60 mm wide and 20 mm high.

The trunking consists of two chambers, capacity per chamber:  
two cables of 8.5 mm diameter or three cables of 7.5 mm diameter or  
four cables of 7.0 mm diameter or five cables of 6.0 mm diameter.

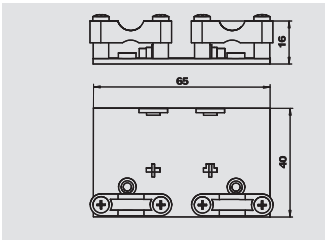

## Holder with strain relief for Flexkanal

Type	Colour	Pack	Weight	Item no.
		Units	kg/100 pc.	
<b>FLK-HL ZL</b>	Anthracite grey	1	1.030	<b>6154 96 1</b>



/pc.

The holder possesses two integrated strain reliefs and can be screwed on. A Flexkanal can be mounted directly on the holder.

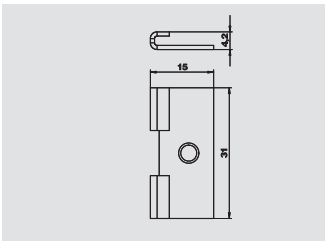

## Fastening clamp for Flexkanal

Type	Pack	Weight	Item no.
	Units	kg/100 pc.	
<b>FLK-BEF</b>	1	0.146	<b>6154 96 8</b>

Al Aluminium

/pc.

The Flexkanal is suspended from the fastening clamp. The holder is fastened using a counter-sunk union.

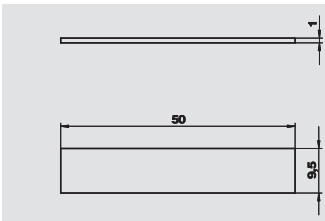

## Adhesive tapes for Flexkanal

Type	Length	Pack	Weight	Item no.
	mm	Units	kg/100 pc.	
<b>FLK-KL</b>	50	1	0.100	<b>6154 97 1</b>

/pc.

Adhesive tape for fastening the Flexkanal.

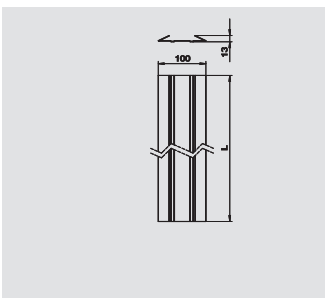

## Floor rail for Flexkanal

Type	Length	Colour	Pack	Weight	Item no.
	mm		Units	kg/100 pc.	
<b>FLK-BS1</b>	1000	Anthracite grey	1	24.800	<b>6154 98 0</b>
<b>FLK-BS2</b>	2000	Anthracite grey	1	49.500	<b>6154 98 3</b>

/pc.

The Flexkanal is pushed directly into the floor rail. The ramp on both sides reduces the risk of stumbling.

Width: 100 mm

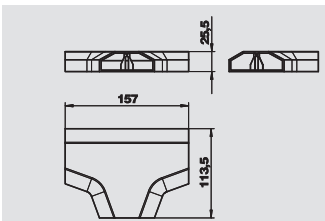

## T branch for Flexkanal

Type	Colour	Pack	Weight	Item no.
		Units	kg/100 pc.	
<b>FLK-TAZ</b>	Anthracite grey	1	8.680	<b>6154 96 5</b>

/pc.

T branch for supply of working places with the Flexkanal.



# Flexkanal and accessories



## Round base outlet for Flexkanal

Type	Colour	Pack	Weight	Item no.
		Units	kg/100 pc.	
<b>BAL-FLK R</b>	Anthracite grey	1	7.700	<b>6154 99 0</b>

/pc.

Base outlet for mounting in raised floors – the Flexkanal can be directly connected to the base outlet.

Drilling diameter: 95 mm

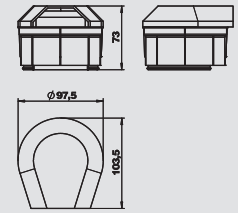

## Rectangular base outlet with lamella for Flexkanal

Type	Colour	Pack	Weight	Item no.
		Units	kg/100 pc.	
<b>BAL-L</b>	Anthracite grey	1	7.000	<b>6154 99 4</b>

/pc.

Base outlet for mounting in raised floors – the Flexkanal can be directly connected to the base outlet.

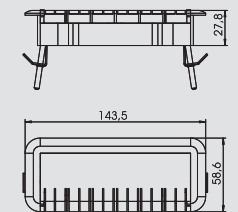

## Rectangular base outlet for Flexkanal

Type	Colour	Pack	Weight	Item no.
		Units	kg/100 pc.	
<b>BAL-FLK E</b>	Anthracite grey	1	7.200	<b>6154 99 2</b>

/pc.

Base outlet for mounting in raised floors – the Flexkanal can be directly connected to the base outlet.

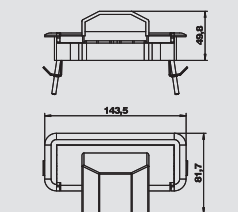

## Base outlet with T branch for Flexkanal

Type	Colour	Pack	Weight	Item no.
		Units	kg/100 pc.	
<b>BAL-FLK TAZ</b>	Anthracite grey	1	12.600	<b>6154 97 5</b>

/pc.

Base outlet for mounting in raised floors – the Flexkanal can be directly connected to the base outlet, complete with T branch.

Drilling diameter: 95 mm.

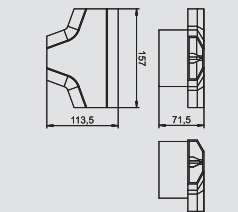

## Fastening bracket for Flexkanal in GES service outlets

Type	Material	Pack	Weight	Item no.
		Units	kg/100 pc.	
<b>FKH GES5</b>	St	1	1.800	<b>7407 86 0</b>

**St** Steel **FS** Strip galvanised /pc.

Fixing bracket to connect a Flexkanal to a GES service outlet with 5 mm floor covering recess.



Type	Material	Pack	Weight	Item no.
		Units	kg/100 pc.	
<b>FKH GES10</b>	St	1	2.000	<b>7407 86 2</b>

**St** Steel **FS** Strip galvanised /pc.

Fixing bracket to connect a Flexkanal to a GES service outlet with 10 mm floor covering recess.

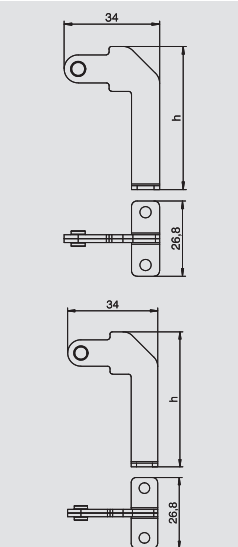

## Fastening bracket for Flexkanal in GESRM2 service outlets

Type	Material	Pack	Weight	Item no.
		Units	kg/100 pc.	
<b>FKH GESRM</b>	St	1	1.500	<b>7407 86 4</b>

**St** Steel **FS** Strip galvanised /pc.

Fixing bracket to connect a Flexkanal to the service outlet GESRM2.

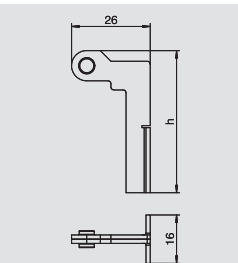



## Selection of country-specific sockets

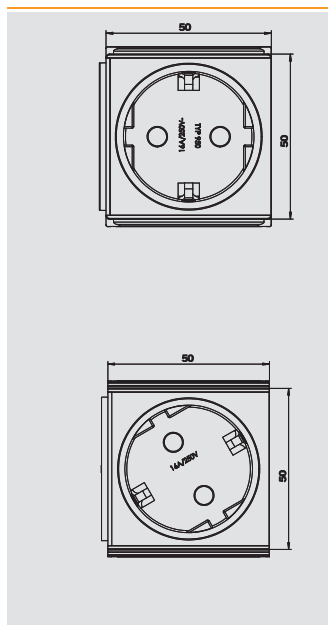

### Sockets – protective contact

Type	Colour	Item no.
EBG-D0 SW	Black	
EBG-D0 RO	Red	
EBG-D0 GN	Green	
EBG-D0 CRW	Cream	
EBG-D0 RW	Pure white	
EBG-D0 LGR	Light grey	

/pc.

Protective contact socket, 16 A, 0° connection direction.

Type	Colour	Item no.
EBG-D6 SW	Black	
EBG-D6 RO	Red	
EBG-D6 GN	Green	
EBG-D6 CRW	Cream	
EBG-D6 RW	Pure white	
EBG-D6 LGR	Light grey	

/pc.

Protective contact socket, 16 A, 60° connection direction.

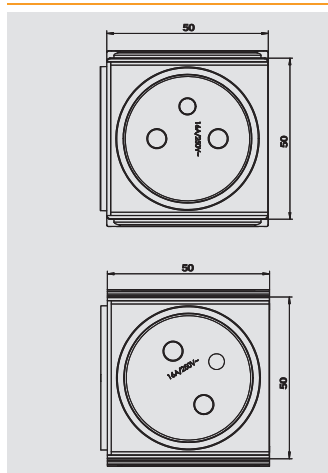

### Socket – earthing pin

Type	Colour	Item no.
EBG-F0 SW	Black	
EBG-F0 RO	Red	

/pc.

Socket with earthing pin, 16 A, 0° connection direction, with touch protection.

Type	Colour	Item no.
EBG-F6 SW	Black	
EBG-F6 RO	Red	

/pc.

Socket with earthing pin, 16 A, 60° connection direction, with touch protection.

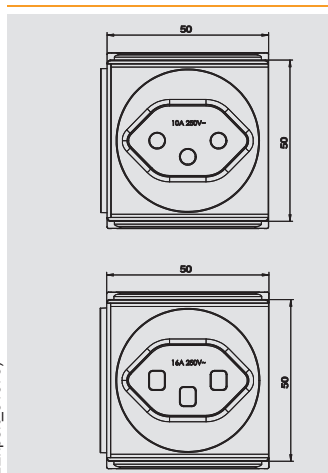

### Sockets – Switzerland

Type	Colour	Item no.
EBG-CH0 10SW	Black	
EBG-CH0 10RO	Red	

/pc.

Socket, Switzerland, 10 A, 0° connection direction.

Type	Colour	Item no.
EBG-CH0 16SW	Black	
EBG-CH0 16RO	Red	

/pc.

Socket, Switzerland, 16 A, 0° connection direction.

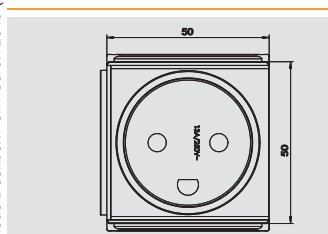

### Sockets – Denmark

Type	Colour	Item no.
EBG-DK0 SW	Black	

/pc.

Socket, Denmark, 13 A, 0° connection direction, with touch protection.

# Selection of country-specific sockets



## Sockets – Denmark

Type	Colour	Item no.
EBG-DKE0 SW	Black	
EBG-DKE0 RO	Red	

/pc.

Socket, Denmark, 13 A, 0° connection direction, with touch protection, encoded for IT circuit.

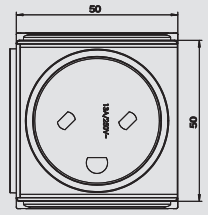

## Sockets – British Standard

Type	Colour	Item no.
EBG-BS3 SW	Black	
EBG-BS3 RO	Red	

/pc.

British Standard socket, 13 A, 30° connection direction, with touch protection.



Type	Colour	Item no.
EBG-BSS3 3.15SW	Black	
EBG-BSS3 3.15RO	Red	

/pc.

British Standard socket with integrated fuse, 3.15 A, 30° connection direction, with touch protection.



Type	Colour	Item no.
EBG-BSS3 5SW	Black	
EBG-BSS3 5RO	Red	

/pc.

British Standard socket with integrated fuse, 5 A, 30° connection direction, with touch protection.

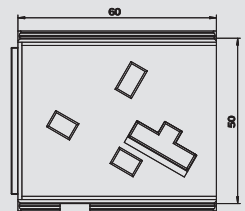
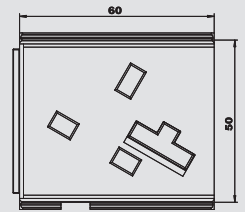
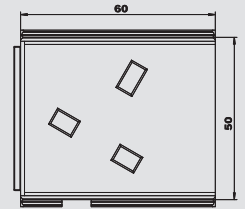

## Sockets – Italy

Type	Colour	Item no.
EBG-IT0 SW	Black	

/pc.

Socket, Italy, 10 A/16 A, 0° connection direction, with touch protection.

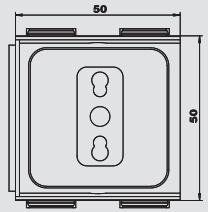

## Sockets – Australia

Type	Colour	Item no.
EBG-AU0 SW	Black	
EBG-AU0 RO	Red	

/pc.

Socket, Australia, 10 A, 0° connection direction.



Type	Colour	Item no.
EBG-AU6 SW	Black	
EBG-AU6 RO	Red	

/pc.

Socket, Australia, 10 A, 60° connection direction.

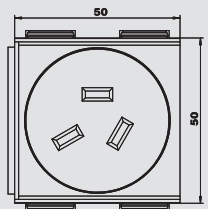
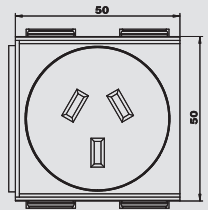

## Sockets – China

Type	Colour	Item no.
EBG-CN0 SW	Black	
EBG-CN0 RO	Red	

/pc.

Socket, China, 10 A, 0° connection direction.

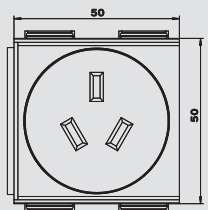

## Selection of country-specific sockets

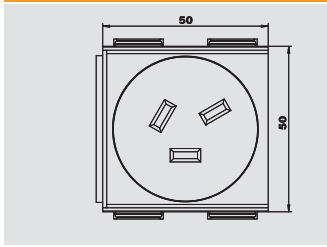

### Sockets – China

Type	Colour	Item no.
EBG-CN6 SW	Black	
EBG-CN6 RO	Red	

/pc.

Socket, China, 10 A, 60° connection direction.

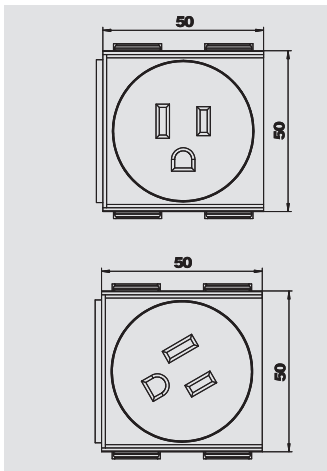

### Sockets – USA, Canada

Type	Colour	Item no.
EBG-US0 SW	Black	
EBG-US0 RO	Red	

/pc.

Socket, USA (NEMA 5-15), 15 A, 0° connection direction.



Type	Colour	Item no.
EBG-US6 SW	Black	
EBG-US6 RO	Red	

/pc.

Socket, USA (NEMA 5-15), 15 A, 60° connection direction.



# Selection of data technology connections



## Data technology connection coupling

Type	Colour	Version	Item no.
<b>EBG-K C6G</b>	Black	RJ45 socket, Cat. 6 screened	

/pc.

Support plate with a data technology coupling RJ45 to RJ45, 1:1 switched, Cat. 6 shielded.

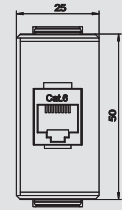

## Data technology connection modules RJ45, R&M

Type	Colour	Version	Item no.
<b>EBG-RM C5G ST3</b>	Black	RJ45 socket, Cat. 5e screened	
<b>EBG-RM C6 ST3</b>	Black	RJ45 socket, Cat. 6, unshielded	
<b>EBG-RM C6G ST3</b>	Black	RJ45 socket, Cat. 6 screened	

/pc.

Support plate with an RJ45 data technology socket (R&M).

Type: EBG-RM C5G ST3

- Cat. 5e shielded, incl. 3.0 m connection cable LANmark6 with RJ45 connector.

Type: EBG-RM C6 ST3

- Cat. 6 unshielded, incl. 3.0 m connection cable LANmark6 with RJ45 connector.

Type: EBG-RM C6G ST3

- Cat. 6 shielded, incl. 3.0 m connection cable LANmark6 with RJ45 connector.

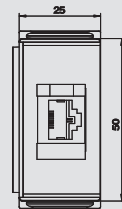

## Data technology connection modules RJ45, Nexans

Type	Colour	Version	Item no.
<b>EBG-N C6 ST3</b>	Black	RJ45 socket, Cat. 6, unshielded	
<b>EBG-N C6G ST3</b>	Black	RJ45 socket, Cat. 6 screened	

/pc.

Support plate with an RJ45 data technology socket (Nexans), incl. connection cable.

Type: EBG-N C6 ST3

- Cat. 6 unshielded, incl. 3.0 m connection cable LANmark6 with RJ45 connector.

Type: EBG-N C6G ST3

- Cat. 6 shielded, incl. 3.0 m connection cable LANmark6 with RJ45 connector.



Type	Colour	Version	Item no.
<b>EBG-N2 C6 ST3</b>	Black	RJ45 socket, Cat. 6, unshielded	
<b>EBG-N2 C6G ST3</b>	Black	RJ45 socket, Cat. 6 screened	

/pc.

Support plate with two RJ45 data technology sockets (Nexans), incl. connection cable.

Type: EBG-N2 C6 ST3

- 2x Cat. 6 unshielded, incl. 3.0 m connection cable LANmark6 with RJ45 connector.

Type: EBG-N2 C6G ST3

- 2x Cat. 6 shielded, incl. 3.0 m connection cable LANmark6 with RJ45 connector.

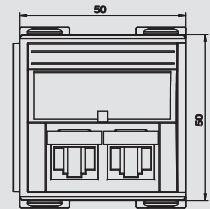
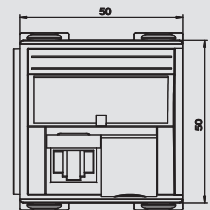

## Data technology connection modules GG45, Nexans

Type	Colour	Version	Item no.
<b>EBG-N C7 ST3</b>	Black	GG45 socket, Cat. 7 shielded	
<b>EBG-N C7A ST3</b>	Black	GG45 socket, Cat. 7A shielded	

/pc.

Support plate with two GG45 data technology sockets (Nexans), incl. connection cable.

Type: EBG-N C7 ST3

- Cat. 7 shielded, incl. 3.0 m connection cable LANmark7 with GG45 connector.

Type: EBG-N2 C7A ST3

- Cat. 7A shielded, incl. 3.0 m connection cable LANmark7 with GG45 connector.

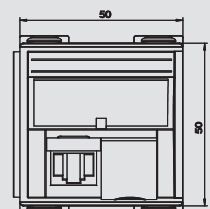



## Selection of data technology connections

### Data technology connection modules GG45, Nexans

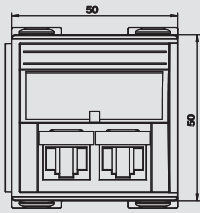

Type	Colour	Version	Item no.
<b>EBG-N2 C7 ST3</b>	Black	GG45 socket, Cat. 7 shielded	
<b>EBG-N2 C7A ST3</b>	Black	GG45 socket, Cat. 7A shielded	

/pc.

Support plate with two GG45 data technology sockets (Nexans), incl. connection cable.

Type: EBG-N2 C7 ST3

- 2x Cat. 7 shielded, incl. 3.0 m connection cable LANmark7 with GG45 connector.

Type: EBG-N2 C7A ST3

- 2x Cat. 7A shielded, incl. 3.0 m connection cable LANmark7 with GG45 connector.



### Telephone connection module, RJ11

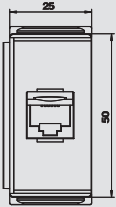

Type	Colour	Version	Item no.
<b>EBG-RJ11 ST3</b>	Black	RJ11 socket, unshielded	

/pc.

Support plate with an RJ11 telephone socket, incl. 3.0 m connection cable with RJ45 connector.



# Selection of multimedia connections



## VGA connection

Type	Colour	Version	Item no.
<b>EBG-VGA ST3</b>	Black	With 3.0 m cable and connector	
<b>EBG-VGA 5BNC3</b>	Black	With 3.0 m cable and 5x BNC connector	
<b>EBG-VGA LA</b>	Black	Without cable, with soldering connection	

/pc.

Support plate with a VGA 15-pole HDD socket, with screw lock.

Type: EBG-VGA ST3  
- 3.0 m connection cable with 15-pole HDD connector.

Type: EBG-VGA 5BNC3  
- 3.0 m connection cable with 5 x BNC (RGB HV) connector.

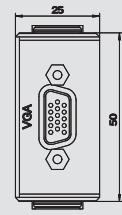

## DVI connection

Type	Colour	Version	Item no.
<b>EBG-DVI-A ST3</b>	Black	With 3.0 m cable and connector	
<b>EBG-DVI-A LA</b>	Black	Without cable, with soldering connection	

/pc.

Support plate with a DVI socket for analogue DVI-A connection 9+5-pole.

Type: EBG-DVI-A ST3  
- 3.0 m connection cable with DVI-A connector, 9+5 contacts.



Type	Colour	Version	Item no.
<b>EBG-DVI-D ST3</b>	Black	With 3.0 m cable and connector	
<b>EBG-DVI-D LA</b>	Black	Without cable, with soldering connection	

/pc.

Support plate with a DVI socket for digital DVI-D connection 18-pole (Single Link).

Type: EBG-DVI-D ST3  
- 3.0 m connection cable with DVI-D connector, 18+1 contacts.

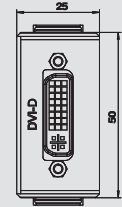
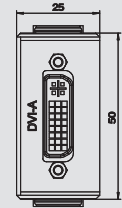

## HDMI connection

Type	Colour	Version	Item no.
<b>EBG-HDMI ST3</b>	Black	With 3.0 m cable and connector	
<b>EBG-HDMI BT0.2</b>	Black	With 0.2 m cable and socket	

/pc.

Support plate with an HDMI socket for one HDMI 1.3 connection.

Type: EBG-HDMI ST3  
- 3.0 m connection cable with HDMI connector, for transmission lengths of up to approx. 25 m.

Type: EBG-HDMI BT0.2  
- 0.2 m connection cable with HDMI socket, to connect HDMI connection cables, for transmission lengths of up to approx. 25 m.

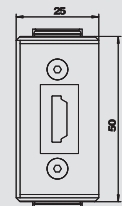

## Video connection

Type	Colour	Version	Item no.
<b>EBG-VHS SVHS ST3</b>	Black	Each with 3.0 m cable and connector	
<b>EBG-VHS SVHS LA</b>	Black	Without cable, with soldering connection	

/pc.

Support plate with a 4-pole Mini-DIN socket for S-Video connection (S-VHS) and a cinch socket (RCA) for Composite Video connection (VHS).

Type: EBG-VHS SVHS ST3  
- Composite Video: 3.0 m connection cable with cinch connector.  
- S-Video: 3.0 m connection cable with 4-pole Mini-DIN connector.

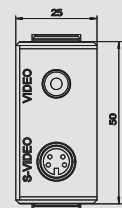

## Selection of multimedia connections

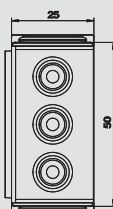
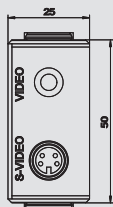
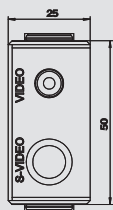

### Video connection

Type	Colour	Version	Item no.
<b>EBG-VHS ST3</b>	Black	With 3.0 m cable and connector	
<b>EBG-VHS LA</b>	Black	Without cable, with soldering connection	

/pc.

Support plate with a cinch socket (RCA) for Composite Video connection (VHS).

Type: EBG-VHS ST3  
- 3.0 m connection cable with cinch connector.

Type	Colour	Version	Item no.
<b>EBG-SVHS ST3</b>	Black	With 3.0 m cable and connector	
<b>EBG-SVHS LA</b>	Black	Without cable, with soldering connection	

/pc.

Support plate with a 4-pole Mini-DIN socket for S-Video connection (S-VHS).

Type: EBG-SVHS ST3  
- 3.0 m connection cable with 4-pole Mini-DIN connector.

Type	Colour	Version	Item no.
<b>EBG-CV 3RCA ST3</b>	Black	With 3.0 m cable and connector	
<b>EBG-CV 3RCA LA</b>	Black	Without cable, with soldering connection	

/pc.

Support plate with three cinch sockets (RCA) for Component Video Connection.

Type: EBG-CV 3RCA ST3  
- 3.0 m connection cable with 3 x cinch connectors (green Y, blue PB, red PR).

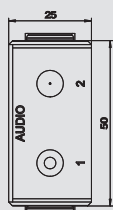
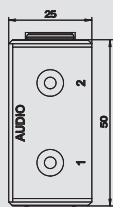
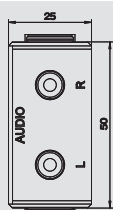

### Audio connection

Type	Colour	Version	Item no.
<b>EBG-LR RCA ST3</b>	Black	With 3.0 m cable and connector	
<b>EBG-LR RCA LA</b>	Black	Without cable, with soldering connection	

/pc.

Support plate with two cinch sockets (RCA) for L/R audio inputs (stereo).

Type: EBG-LR RCA ST3  
- 3.0 m connection cable with cinch connector.

Type	Colour	Version	Item no.
<b>EBG-12KL ST3</b>	Black	Each with 3.0 m cable and connector	
<b>EBG-12KL LA</b>	Black	Without cable, with soldering connection	

/pc.

Support plate with two jack sockets 3.5 mm for 1/2 audio inputs (stereo).

Type: EBG-12KL ST3  
- Two 3.0 m connection cables with 3.5 mm jack connector.

Type	Colour	Version	Item no.
<b>EBG-1KL ST3</b>	Black	With 3.0 m cable and connector	
<b>EBG-1KL LA</b>	Black	Without cable, with soldering connection	

/pc.

Support plate with a jack socket 3.5 mm for audio input 1 (stereo).

Type: EBG-1KL ST3  
- 3.0 m connection cable with 3.5 mm jack connector.



## Selection of multimedia connections



### Serial connection

Type	Colour	Version	Item no.
<b>EBG-SER9 BU3</b>	Black	With 3.0 m cable and socket	
<b>EBG-SER9 LA</b>	Black	Without cable, with soldering connection	

/pc.

Support plate with a serial 9-pole D-SUB connector, with screw connection.

Type: EBG-SER9 ST3  
- 3.0 m connection cable with serial 9-pole D-Sub socket.

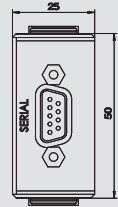

### USB connection

Type	Colour	Version	Item no.
<b>EBG-USB2A ST3</b>	Black	With 3.0 m cable and connector	

/pc.

Support plate with USB 2.0, type A socket, to connect standard USB devices, incl. 3.0 m connection cable with USB connector, type A.

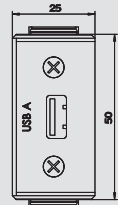

### Antenna connection

Type	Colour	Version	Item no.
<b>EBG-TV-R ST2.5</b>	Black	Each with 2.5 m cable and connector/socket	

/pc.

Support plate with TV connector and radio socket, including connection cable.

Cable  
- TV: 2.5 m connection cable with TV socket, coaxial 75 Ohms, shielding >90 dB.  
- Radio: 2.5 m connection cable with radio connection, coaxial 75 Ohms, shielding >90 dB.

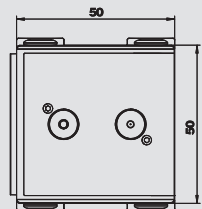

### Connection combinations

Type	Colour	Version	Item no.
<b>EBG-VGA 1KL ST3</b>	Black	Each with 3.0 m cable and connector	
<b>EBG-VGA 1KL LA</b>	Black	Without cable, with soldering connection	

/pc.

Support plate with a VGA 15-pole HDD socket, with screw lock and a jack socket 3.5 mm for audio input (stereo).

Type: EBG-VGA 1KL ST3  
- VGA: 3.0 m connection cable with VGA 15-pole HDD connector.  
- Jack: 3.0 m connection cable with 3.5 mm jack connector.

Type	Colour	Version	Item no.
<b>EBG-VHS 1KL ST3</b>	Black	Each with 3.0 m cable and connector	
<b>EBG-VHS 1KL LA</b>	Black	Without cable, with soldering connection	

/pc.

Support plate with a jack socket 3.5 mm for audio input (stereo) and a cinch socket (RCA) for Composite Video connection (VHS).

Type: EBG-VHS 1KL ST3  
- Jack: 3.0 m connection cable with 3.5 mm jack connector.  
- Composite Video: 3.0 m connection cable with cinch connector.

Type	Colour	Version	Item no.
<b>EBG-SVHS RCA ST3</b>	Black	Each with 3.0 m cable and connector	
<b>EBG-SVHS RCA LA</b>	Black	Without cable, with soldering connection	

/pc.

Support plate with a 4-pole Mini-DIN socket for S-Video connection (S-VHS) and two cinch sockets (RCA) for L/R audio inputs (stereo).

Type: EBG-SVHS RCA ST3  
- S-Video: 3.0 m connection cable with 4-pole Mini-DIN connector.  
- Audio: 3.0 m connection cable with cinch connector.

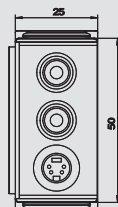
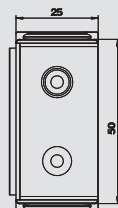
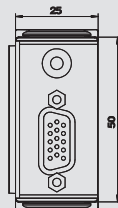



## Selection of protective elements

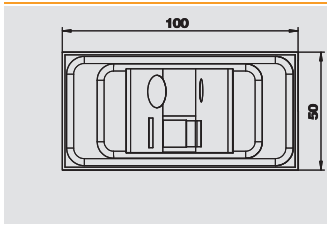

### Residual current circuit-breaker

Type	Colour	Version	Item no.
<b>EBG-FIS16</b>	Black	Nominal current 16 A, sensitivity 10 mA	

/pc.

Residual current circuit-breaker RCCB (FI switch), 2-pole B-characteristics, type A.

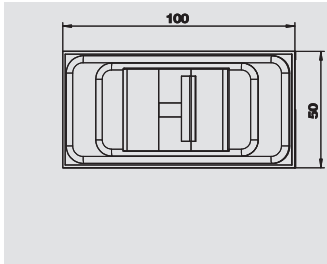

### Circuit-breaker

Type	Colour	Version	Item no.
<b>EBG-LSS10</b>	Black	Nominal current 10 A	
<b>EBG-LSS13</b>	Black	Nominal current 13 A	
<b>EBG-LSS16</b>	Black	Nominal current 16 A	

/pc.

MCB circuit-breaker (LS switch), 2-pole, B characteristics.

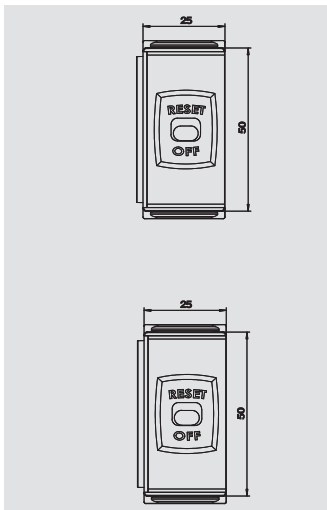

### Overload switch

Type	Colour	Item no.
<b>EBG-ÜLS USO</b>	Black	

/pc.

Overload switch, 15 A, 125 V~, 1-pole, as sliding switch, required for three sockets for USA/Canada.

Note: Can only be ordered in conjunction with sockets (type: Australia).

Type	Colour	Item no.
<b>EBG-ÜLS AU0</b>	Black	

/pc.

Overload switch, 10 A, 250 V~, 1-pole, as sliding switch, required for three sockets for Australia.

Note: Can only be ordered in conjunction with sockets (type: USA).

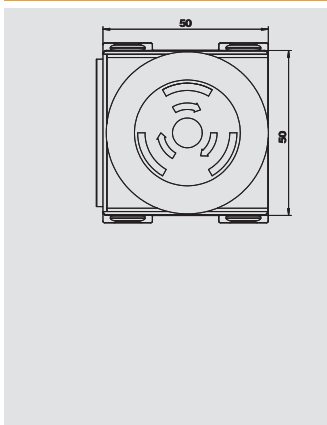

### Emergency Stop button

Type	Colour	Version	Item no.
<b>EBG-NHT OST3</b>	Black	With 3.0 m cable without connector	

/pc.

Emergency Stop button with protective collar and label (EMERGENCY STOP), overload-protected EN IEC 60947-5-5, rotary unlock in clockwise direction, incl. 3.0 m connection cable without plug.

Lighting: LED (lit in red), 12 V DC external  
 Contacts: 2 NC  
 Switching function: Locking function  
 Switching system: Button switching element  
 Current consumption: 9.7 to 12.4 mA  
 Switching power: 250 V AC, 5 A



## Selection switching devices and accessories



### One-way switch, lit in blue

Type	Colour	Item no.
EBG-EAS	Black	

/pc.

One-way switch (lit in blue), 16 A, 230 V $\sim$ .

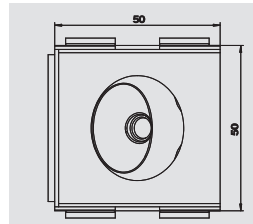

### Switch

Type	Colour	Version	Item no.
EBG-TA1 OST3	Black	With 3.0 m cable without connector	

/pc.

Single switch, NO contact, 1-pole, switching power max. 42 V AC/DC, 100 mA, incl. 3.0 m connection cable without connector.

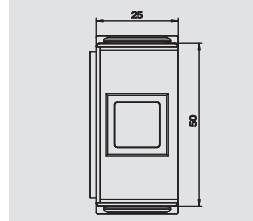

### Radio receiver, EnOcean

Type	Colour	Item no.
EBG-FEP 2K	Black	

/pc.

2-channel radio receiver to switch sockets or consumers such as lamps, switching states ON/OFF with switching state display, 230 V $\sim$  voltage, actuator switching output max. 16 A, for radio transmitters from the EnOcean series.

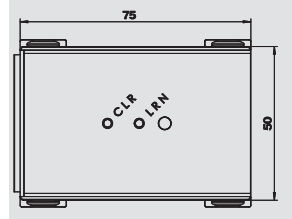

### Radio transmitter, EnOcean

Type	Colour	Item no.
EBG-FMS 4K	Black	

/pc.

4-channel radio transmitter with two switching rockers to control all EnOcean radio receivers, range up to 30 m.

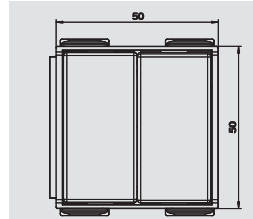

Type	Colour	Item no.
EBG-FMS 2K	Black	

/pc.

2-channel radio transmitter with a switching rocker to control all EnOcean radio receivers, range up to 30 m.

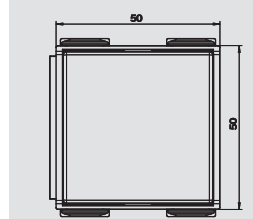

### Inscription label

Type	Colour	Item no.
EBG-BF	Black	

/pc.

Inscription label for individual labelling of the devices.

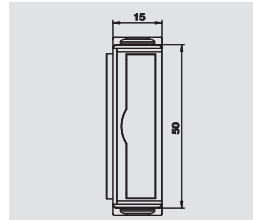

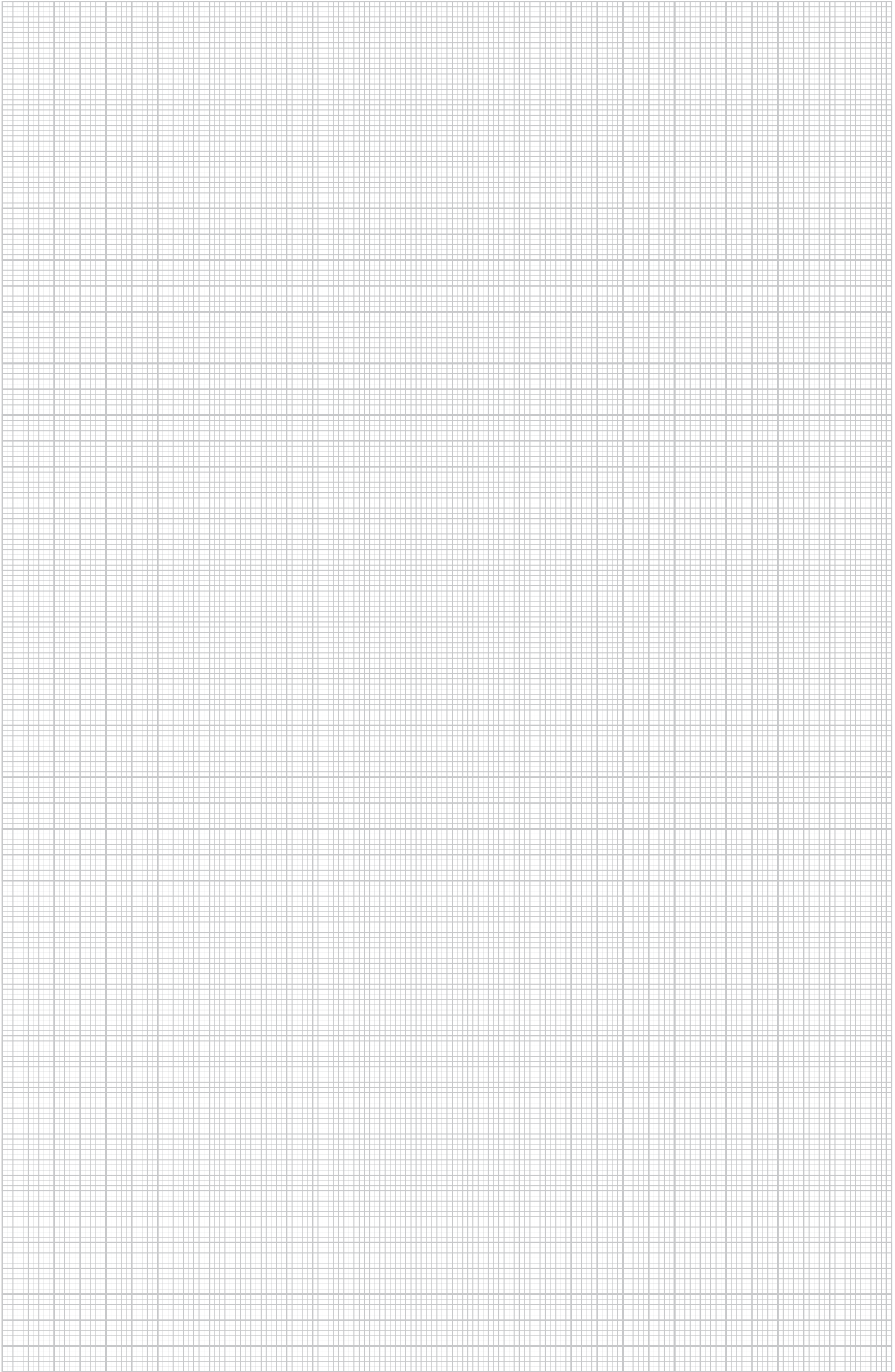

[www.obo-bettermann.com](http://www.obo-bettermann.com)



**OBO Bettermann GmbH & Co. KG**

PO Box 1120  
58694 Menden, Germany

**Customer Service Germany**

Tel.: +49 (0)2373 89-1500  
Fax: +49 (0)2373 89-7777  
E-mail: [info@obo.de](mailto:info@obo.de)

© OBO BETTERMANN Order no. 9170190 07/2010 EN

**THINK CONNECTED.**