

Technical data sheet

Connection thread sealing ring, metric

Item no. 2088452



Asbestos-free material.
Connection thread sealing ring, Part 9, to DIN 46320, suitable for all brass cable glands with metric connection thread to DIN EN 60423 or ISO 68.
Colour: green, graphited on one side.



FA Fibre-proof material DIN 28091

Master data

Item no.	2088452
Type	170 M32
Description 1	Sealing ring
Description 2	Asbestos-free
Dimension	M32
Material	Fibre sealing material
Material symbol	FA
Smallest sales unit (VG)	100 Piece
Weight	0,27 kg/100 pc.

Technical data

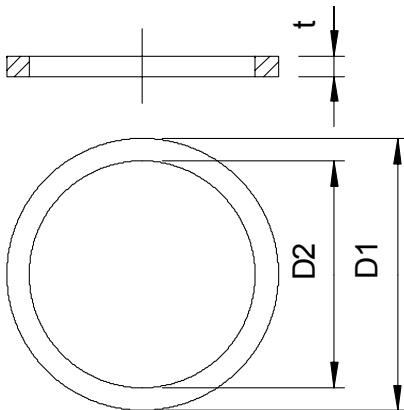

Dimension D1	38,00 mm
Dimension D2	32,00 mm
Dimension t	3,00 mm
Version for	Flat sealing ring
External diameter	38,00 mm
Inner diameter	32,00 mm
For thread dimension, metric	32
Size	M32 mm
Halogen-free	<input type="checkbox"/>
Thickness	3,00 mm