

Technical data sheet

UZD250-3 for screed height 115–170 mm

Item number: 7410043

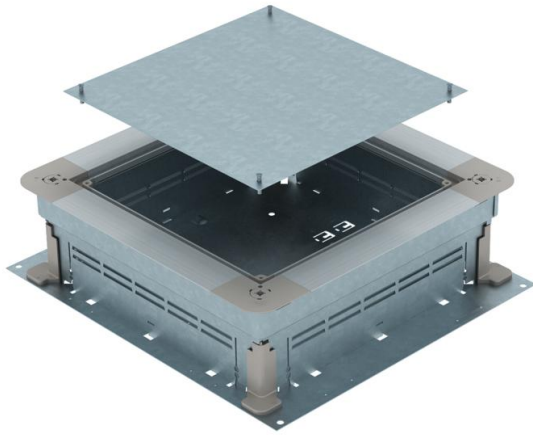

Underfloor junction and branch box for screed-covered underfloor installation ducts with sheet steel side walls. To mount installation units in the mounting lid (to be ordered separately). Height can be infinitely adjusted to the nominal screed height (rapid adjustment possible) and the screed can be worked flush to the screed scraping edge. With noise decoupling option after screed laying and can be used with system accessories, also for heavy-duty application. Side walls prepared for duct width 250 mm.



- St** Steel
- FS** Strip galvanized

Master data

Item number	7410043
Type	UZD 115170 250-3
Description 1	Junction and branch box
Description 2	for screed height 115-170mm
Manufacturer	OBO
Dimension	410x367x115
Material	Steel
Surface	Strip galvanized
Surface standard	DIN EN 10346
Smallest sales unit	1
Unit of quantity	Piece
Weight	480 kg
Weight unit	kg/100 pc.

Technical data sheet

UZD250-3 for screed height 115–170 mm

Item number: 7410043



Dimensions

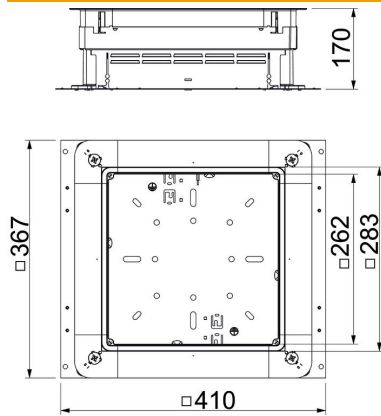

Dimension a	262 mm
Dimension A	367 mm
Dimension B	410 mm
Dimension b	283 mm

Technical data

Floor plate	yes
Lowerable to be flush-floor	no
Cover version	Universal
Seal installation option	yes
Installation opening for on-floor tank	no
Decouplable	yes
Screed height, max.	170 mm
Screed height, min.	115 mm
For pipe connection	no
Suitable for screed-flush closed underfloor ducts	no
Suitable for screed-covered underfloor ducts	yes
Suitable for underfloor ducts	no
Installation space, max.	16.16 dm ³
Installation space, min.	10.62 dm ³
Trunking width, max.	350 mm
Trunking width, min.	190 mm
Trunking height, max.	48 mm
Duct height, min.	28 mm
Minimum screed height	115
Nominal size	250 mm
Height-adjustment range, max.	170 mm
Height-adjustment range, min.	115 mm