

Technical data sheet

Surge arrester V20, 3-pole + NPE and remote signalling, 320 V
Item no. 5095343



Surge arrester, type 2

- For surge voltage protection equipotential bonding to VDE 0100-443 (IEC 60364-4-44)
- Discharge capacity to 40 kA (8/20) per pole through high-performance varistors
- Modular connectable arrester with cut-off unit and visual status display
- Locking mechanism with vibration protection and voltage keying
- Plastic to UL 94 V-0
- The remote signalling variants (FS) have a potential-free changeover contact for remote signalling

Application: Equipotential bonding in main and sub-distributions.



Dimensions

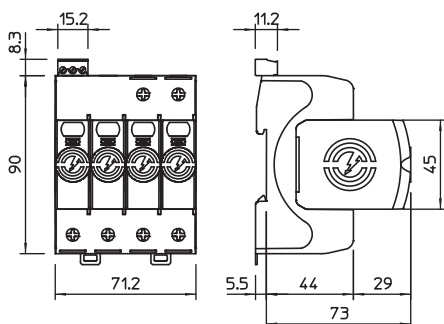

Master data

Item no.	5095343
Type	V20-3+NPE+FS-320
Description 1	SurgeController V20
Description 2	3-pole with NPE + RS
Dimension	320V
Smallest sales unit (VG)	1 Piece
Weight	46,60 kg/100 pc.

Technical data sheet

Surge arrester V20, 3-pole + NPE and remote signalling, 320 V
Item no. 5095343



Technical data

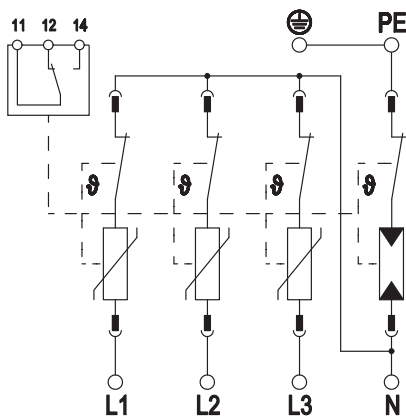

SPD to EN 61643-11	Type 2
SPD to IEC 61643-11	Class II
SPD to UL 1449	Type 4
Test class, type 2	<input checked="" type="checkbox"/>
Nominal voltage AC (50/60 Hz)	230,00 V
Maximum continuous voltage AC	320,00 V
Maximum continuous voltage (L-N)	320,00 V
Maximum continuous voltage (N-PE)	255,00 V
Nominal discharge current (8/20 µs)	20,00 kA
Nominal discharge current (8/20 µs) [L-N]	20,00 kA
Nominal discharge current (8/20 µs) [N-PE]	40,00 kA
Maximum discharge current (8/20 µs)	40,00 kA
Maximum discharge current (8/20 µs) [L-N]	40,00 kA
Maximum discharge current (8/20 µs) [N-PE]	60,00 kA
Arrester surge current (8/20 µs) [total]	60,00 kA
Combined voltage protection level [L-PE]	1,70 kV
Protection level	1,40 kV
Protection level [L-N]	1,40 kV
Protection level [N-PE]	1,30 kV
Residual voltage [L-N] @ 1 kA	1,0 kV
Residual voltage [L-N] @ 5 kA	1,2 kV
Follow current quenching capacity (eff) [N-PE]	0,10 kA
Response time [L-N]	25 ns
Response time [N-PE]	100 ns
Max. mains-side overcurrent protection	160 A gL/gG
Short-circuit withstand for max. mains-side overcurrent protection	50 kA eff
Short-circuit resistant	<input checked="" type="checkbox"/>
TOV voltage [L-N] – fail safe mode – 120 min.	440,00 V
TOV voltage [L-N] – withstand mode – 5 s	335,00 V
TOV voltage [N-PE] – withstand mode – 200 ms	1.200,00 V
Operating temperature range	-40+80 °C
Humidity	5,00 - 95,00 %
Function/defect display	Optical
Ports	One-Port SPD
Pole version	3+N/PE
Pole number	4
Connection cross-section (min.)	1,50 mm ²
Connection cross-section (max.)	35,00 mm ²
Connection cross-section (min.)	16,00 AWG
Connection cross-section (max.)	2,00 AWG
Torque	4,00 Nm
Torque	35,00 Lbs
Mounting type	Hat rail 35 mm
Housing material	PA UL 94 V-0

Technical data sheet

Surge arrester V20, 3-pole + NPE and remote signalling, 320 V
Item no. 5095343



Technical data

Installation location	Interior
Protection rating	IP20
Installation dimensions (LxWxH)	90x71,2x78,5 mm
Minimum distance	1,50 mm
Approvals	
FM contacts	Changeover
Switching power AC	230 V; 0,5 A
Switching power DC	230 V; 0,1 A / 75 V; 0,5 A
Connection cross-section, FM terminals	0,5-1,5 mm ²
Connection cross-section, FM terminals	21-16 AWG
Torque for FM terminal	0,20 Nm
Torque for FM terminal	1,70 Lbs
Protective conductor current	< 2 µA
Blow-out	<input type="checkbox"/>
Size	4 part units
Remote signalling	<input checked="" type="checkbox"/>
Integrated back-up fuse	<input type="checkbox"/>
Max. cable cross-section flexible (fine-wire)	35,00 mm ²
Max. cable cross-section rigid (single wire/multi-wire)	35,00 mm ²
Conductor cross-section, flexible (fine-wire)	1,50 - 35,00 mm ²
Conductor cross-section, flexible (fine-wire)	16,00 - 2,00 AWG
Conductor cross-section, rigid (single wire/multi-wire)	16,00 - 2,00 AWG
Conductor cross-section, rigid (single wire/multi-wire)	1,50 - 35,00 mm ²
Signalling on device	Visual