

Technical data sheet

Fine protection device TELE 4-F for ISDN RJ45

Item number: 5081984



Data line protection device for analogue telecommunications systems

- In aluminium housing
- With 2-stage protection circuit
- Simple mounting
- Incl. 150 mm connection cable with RJ11 and/or RJ45 connectors
- Optimised bandwidth for TC systems
- DIN rail mounting with DLS-BS accessories (5082 38 2)

Application: For analogue telecommunication systems

- In aluminium housing
- Simple mounting on hat rail or on terminal
- Incl. 150 mm connection cable with RJ411 connectors
- Optimised bandwidth for telecommunications systems



Master data

Item number	5081984
Type	RJ45-TELE 4-F
Description 1	Fine protection device
Description 2	for analogue telecommunication
Manufacturer	OBO
Dimension	170V
Smallest sales unit	1
Unit of quantity	Piece
Weight	14 kg
Weight unit	kg/100 pc.

Technical data sheet

Fine protection device TELE 4-F for ISDN RJ45

Item number: 5081984



Technical data

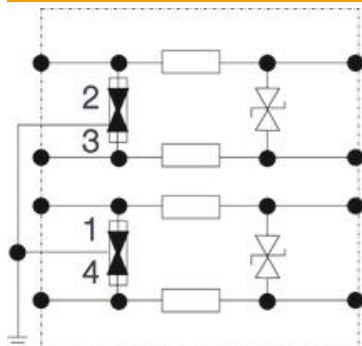

Number of poles	4
Version for	Fine protection, 4 wires
Insertion loss	≤3 dB
Earthing via:	Connection cable
Total discharge current (8/20)	4 kA
Cut-off frequency	18 MHz
Maximum continuous voltage AC	120
Maximum continuous voltage DC	170
Insulation resistance	> 34 MΩ
Capacity (wire-wire)	<500 pF
Capacity (wire-earth)	<20 pF
Kategorie	Type 2+3 / C2+C1
Lightning protection zone LPZ	1→3
Mounting type	Connector/cable adapter
Nominal load current AC	0.2
Nominal load current DC	0.3 A
Testing standard	IEC 61643-21
Protection rating	IP40
Protection level wire-wire	<300 V
Protection level wire-earth	<600 V
Protection level, wire-earth at 1 kV/μs (C3)	<245
Series resistance per wire	2,2 Ω ± 10 %
Signalling on device	Without
SPD to IEC 61643-21	Class II+III / C2+C1
Plug-in system	RJ45
Impulse durability wire-wire	C1: 1 kV / 0,5 kA (8/20)
Impulse durability wire-earth	C2: 2 kV / 1 kA (8/20)
Permitted temperature range, max.	80 °C
Permitted temperature range, min.	-40 °C
Cable type for surge protection devices	Telecommunications line